

Member of the BPW Group



# **FORZALINE®**

## Tilbehør & Reservedele





|   |  |         |
|---|--|---------|
|    | Ramper   | 4 - 9   |
|    | Lastsurring, presenningstilbehør, presenninger, trailernet | 10 - 19 |
|    | Stik og belysning  | 20 - 23 |
|    | Kuglekobling, låse, støttehjul/ben, klembøjler             | 24 - 32 |
|    | Hjul/tilbehør, skærme                                      | 33 - 35 |
|   | Hængsler, vinkellukkere                                    | 36 - 37 |
|  | Bremsekabler, lejer, tætningsringe, bremsebakkesæt         | 38 - 49 |
|  | Støddæmpere, gummibælg, glidebøsning, div. påløbsdele      | 50 - 57 |
|  | Campingvogne, tilbehør                                     | 58 - 61 |
|  | Hestetrailer, tilbehør                                     | 62 - 63 |
|  | Både, tilbehør   | 64 - 71 |
|  | Øvrige varer, tilbehør                                     | 72 - 73 |
|   | Kontaktoplysninger   | 74      |

## Safety Ramps / opkørselsramper

Lige - sæt med 2 stk.

|   | Betegnelse              | Belastning pr. sæt | Varenummer   |
|---|-------------------------|--------------------|--------------|
|  | Alurampe, 1500 x 200 mm | 400 kg             | 55.1500L-200 |
|   | Alurampe, 2000 x 200 mm | 400 kg             | 55.2000L-200 |
|   | Alurampe, 1500 x 260 mm | 1.000 kg           | 55.1500L-260 |
|   | Alurampe, 2000 x 260 mm | 1.000 kg           | 55.2000L-260 |
|   | Alurampe, 2500 x 260 mm | 1.000 kg           | 55.2500L-260 |
|   | Alurampe, 3000 x 260 mm | 1.000 kg           | 55.3000L-260 |

## Safety Ramps / opkørselsramper

Buet - sæt med 2 stk.

|  | Betegnelse              | Belastning pr. sæt | Varenummer   |
|--|-------------------------|--------------------|--------------|
|  | Alurampe, 1500 x 200 mm | 400 kg             | 55.1500B-200 |
|  | Alurampe, 2000 x 200 mm | 400 kg             | 55.2000B-200 |
|  | Alurampe, 2000 x 260 mm | 1.000 kg           | 55.2000B-260 |
|  | Alurampe, 2500 x 260 mm | 1.000 kg           | 55.2500B-260 |

Materialetykkelse:

200 mm bred rampe - 3 mm

260 mm bred rampe - 4 mm

Alle vore ramper er monteret med forstærket anlægsflade + 3 mm - Rekvirer special brochure

## PRO Safety Ramps / opkørselsramper

Lige - sæt med 2 stk.

|   | Betegnelse              | Belastning pr. sæt | Varenummer      |
|---|-------------------------|--------------------|-----------------|
|  | Alurampe, 2000 x 260 mm | 2.000 kg           | 55.2000L-260-2t |
|   | Alurampe, 2000 x 260 mm | 4.000 kg           | 55.2000L-260-4t |
|   | Alurampe, 2500 x 260 mm | 2.000 kg           | 55.2500L-260-2t |
|   | Alurampe, 2500 x 260 mm | 4.000 kg           | 55.2500L-260-4t |
|   | Alurampe, 3000 x 260 mm | 2.000 kg           | 55.3000L-260-2t |
|   | Alurampe, 3000 x 260 mm | 4.000 kg           | 55.3000L-260-4t |

## Monteringsbeslag

| Skitse   | Betegnelse / Udførelse   | Varenummer |
|--|--|------------|
|  | <b>Monteringsbeslag for Safety Ramps</b><br>Passer til 200 mm og 260 mm udførsel | 55.SRF-01  |

## Pro Ramps / opkørselsramper

Lige - sæt med 2 stk.

|  | Betegnelse   | Belastning pr. sæt | Varenummer        |
|--|--|--------------------|-------------------|
|   | <b>Sæt aluramper</b><br>2430 x 270 x 80 mm.,<br>indvendig køre-bredde 210 mm,<br>med anti-skrid overflade.<br>Opkørselshøjde: Minimum 580 mm<br>- Maximum 650 mm.<br>Rampens vægt: 33 kg/sæt | 2.500 kg           | 55.2400L-270P     |
|  | <b>Sæt aluramper</b><br>2580 x 350 x 98 mm.,<br>indvendig køre-bredde 290 mm,<br>med anti-skrid overflade.<br>Opkørselshøjde: Minimum 594 mm -<br>Maximum 660 mm.<br>Rampens vægt: 44 kg/sæt | 3.500 kg           | 55.2580L-350P     |
|  | <b>Sikringsbeslag i aluminium</b><br>inklusiv split og bolt  |                    | 55.2600L-350P-005 |

Specielt velegnet til trailere med 2- og 3-vejs tip

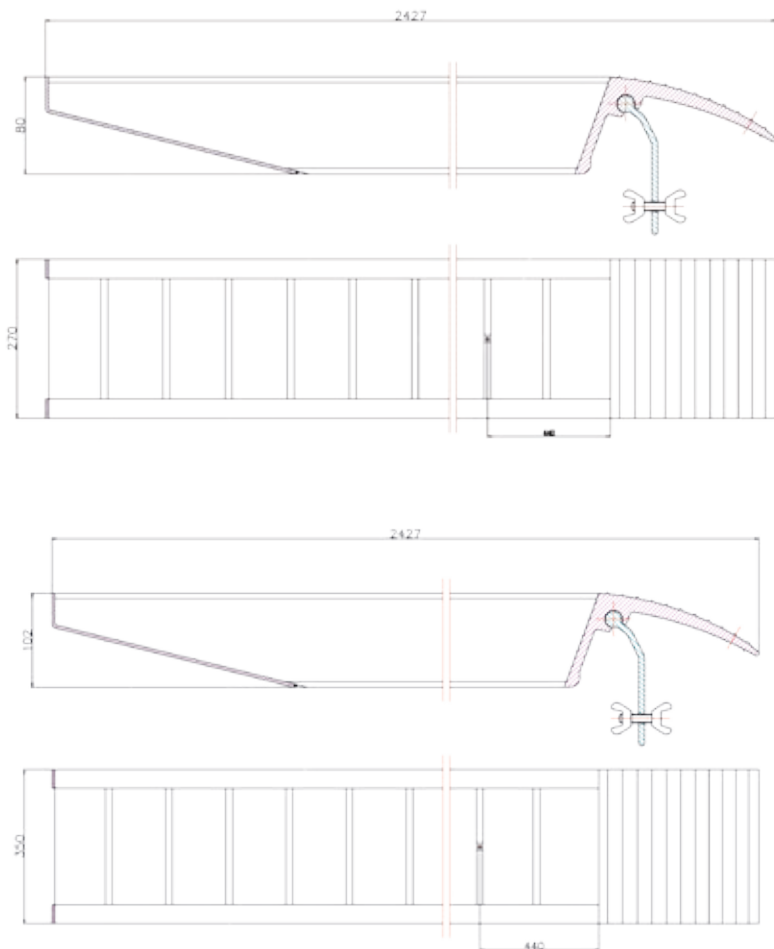

## Van Ramp - Aluramper

|   | Betegnelse   | Belastning | Varenummer    |
|---|--|------------|---------------|
|    | <b>Alurampe</b><br>2000 x 700 x 75 mm<br>indvendig kørebredde 670 mm, med anti-skrid overflade. Opkørselshøjde: Minimum 550 mm - Maximum 600 mm. Rampens vægt: 23,50 kg  | 750 kg     | 55.2000L-700V |
|   | <b>Alurampe</b><br>2400 x 700 x 75 mm<br>indvendig kørebredde 670 mm, med anti-skrid overflade. Opkørselshøjde: Minimum 670 mm - Maximum 720 mm. Rampens vægt: 28,20 kg  | 750 kg     | 55.2400L-700V |
|   | <b>Alurampe</b><br>2800 x 700 x 75 mm<br>indvendig kørebredde 670 mm, med anti-skrid overflade. Opkørselshøjde: Minimum 790 mm - Maximum 840 mm. Rampens vægt: 33 kg     | 750 kg     | 55.2800L-700V |
|   | <b>Alurampe</b><br>3200 x 700 x 75 mm<br>indvendig kørebredde 670 mm, med anti-skrid overflade. Opkørselshøjde: Minimum 828 mm - Maximum 907 mm. Rampens vægt: 37,7 kg   | 500 kg     | 55.3200L-700V |
|  | <b>Alurampe</b><br>3600 x 700 x 75 mm<br>indvendig kørebredde 670 mm, med anti-skrid overflade. Opkørselshøjde: Minimum 948 mm - Maximum 1027 mm. Rampens vægt: 42,5 kg  | 500 kg     | 55.3600L-700V |
|   | <b>Alurampe</b><br>4000 x 700 x 75 mm<br>indvendig kørebredde 670 mm, med anti-skrid overflade. Opkørselshøjde: Minimum 1068 mm - Maximum 1147 mm. Rampens vægt: 42,5 kg | 500 kg     | 55.4000L-700V |

Rampen til trillebøren, græsslåmaskinen, sækkevognen, cyklen, knallerten m.fl.  
Opkørselshjælp til traileren, bilen, trappen, ved trin/læsserampen og meget andet.

Rampen er udstyret med kant på siderne (højde 25 mm), som derved øger sikkerheden under op- og nedkørslen. Indvendig kørebredde 670 mm. Skridsikker bund.

| Foldbar rampe - 200 kg  |   |            |              |
|---|---|------------|--------------|
|   | Betegnelse  | Belastning | Varenummer   |
|  | <b>Foldbar rampe</b><br>Udslået mål: 1795 x 293 x 60 mm<br>Opkørselshøjde 490 - 540 mm<br>Kasse med 1 stk | 200 kg     | 55.1800F-300 |

| Lasterampe  |  |            |              |
|---|--|------------|--------------|
|   | Betegnelse   | Belastning | Varenummer   |
|  | <b>Lasterampe</b><br>I alu dørkplade 3/5 mm, 800 x 800 mm<br>med anlægsnæb | 200 kg     | 55.800L-800D |

| Teleskoprampe   |  |            |               |
|---|--|------------|---------------|
|   | Betegnelse   | Belastning | Varenummer    |
|  | <b>Teleskoprampe</b><br>1220 x 210 / 160 x 50 mm<br>med bærehåndtag, sæt med 2 stk | 300 kg     | 55.1200L-180R |
|   | <b>Teleskoprampe</b><br>1525 x 210 / 160 x 50 mm<br>med bærehåndtag, sæt med 2 stk | 300 kg     | 55.1500L-180R |
|   | <b>Teleskoprampe</b><br>2135 x 210 / 160 x 50 mm<br>med bærehåndtag, sæt med 2 stk | 300 kg     | 55.2100L-180R |





## Kørestolsrampe

|   | Betegnelse   | Belastning | Varenummer    |
|---|--|------------|---------------|
|  | <b>Kørestolsrampe</b><br>915 x 720 / 715 x 50, lige udførsel<br>foldbar med bærehåndtag  | 300 kg     | 55.900L-715R  |
|   | <b>Kørestolsrampe</b><br>1220 x 720 / 715 x 50, lige udførsel<br>foldbar med bærehåndtag | 300 kg     | 55.1200L-715R |

## Overkørselsrampe



|   | Betegnelse  | Belastning | Varenummer |
|---|---|------------|------------|
|  | <b>Overkørselsrampe, aluminium</b><br>sæt, 3 dele, inkl. bolte,<br>Mål: 710 x 605 x 40 mm | 200 kg     | 55.dt3-700 |

| Hjulsurring   |  |               |
|---|--|---------------|
|   | Betegnelse   | Varenummer    |
|  | <p><b>Hjulsurring 2000 kg</b><br/>                     Bånd 35 mm x 2,6 mtr. med J-Krog samt skralde med bånd 35 mm x 0,15 mtr. Strop 50 mm x 0,38 mtr<br/>                     Godkendelse iht. EN12195-2</p> | 117.hs4000-01 |

| Bagagerem   |   |              |
|---|---|--------------|
|   | Betegnelse  | Varenummer   |
|   | <p><b>Bagagerem pakning 2 stk</b><br/>                     Bånd 25 mm x 2,5 m. blå, brudstyrke 500 kg<br/>                     iht. EN12195-2, TÜV/GS-godkendt</p>  | 117.br500-01 |
|  | <p><b>Bagagerem, pakning 2 stk</b><br/>                     Bånd 25 mm x 5,0 m. blå, brudstyrke 500 kg<br/>                     iht. EN12195-2, TÜV/GS-godkendt</p> | 117.br500-02 |

## Surringsbånd

|   | Betegnelse   | Varenummer    |
|---|--|---------------|
|    | <b>Båndsurring, pakning 2 stk.</b><br>LC400 daN, bånd 25 mm x 4,0+0,5 m.<br>Blå, med S-krog, brudstyrke 800 kg.<br>iht. EN12195-2, TÜV/GS-godkendt     | 117.sb800-01  |
|    | <b>Båndsurring, 2 tons</b><br>LC1000 daN, bånd 35 mm x 5,5+0,5 m.<br>Blå, med dobbelt J-krog.<br>iht. EN12195-2, TÜV/GS-godkendt                       | 117.sb2000-01 |
|  | <b>Båndsurring, 2 tons</b><br>LC1000 daN, bånd 50 mm x 4,5+0,8 m.<br>Orange, med krog for indvendig surringsskinne.<br>iht. EN12195-2, TÜV/GS-godkendt | 117.sb2000-02 |
|  | <b>Båndsurring, 4 tons</b><br>LC2000 daN, bånd 50 mm x 9,5+0,5 m.<br>Orange, med dobbelt J-krog.<br>iht. EN12195-2 TÜV/GS-godkendt                     | 117.sb4000-01 |
|  | <b>Båndsurring 5 tons</b><br>LC2500 daN, bånd 50 mm x 9,5+0,5 m.<br>Orange, med dobbelt J-krog.<br>iht. EN12195-2, TÜV/GS-godkendt                     | 117.sb5000-01 |

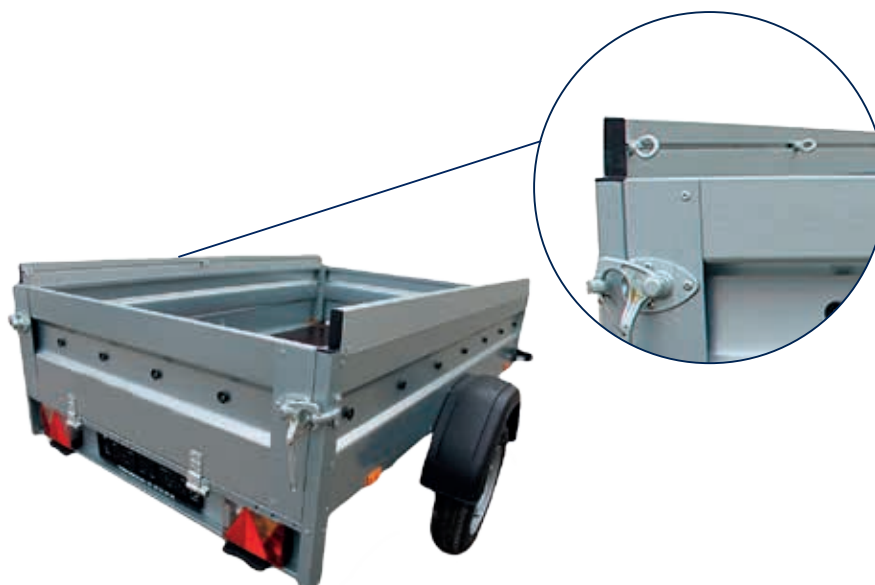

| Ræling profil   |   |            |
|---|---|------------|
|   | Betegnelse  | Varenummer |
|    | <p><b>Ræling-profil, 5800 mm, aluminium</b><br/>Udvendig mål 95 x 29 mm, for påbygning på 25 mm sider, med slidse til montering af flytbare surrings-øjer</p> | 48.rp-5800 |
|    | <p><b>Endeprop, ræling-profil</b></p>   | 48.rp-a    |
|  | <p><b>Surrings-øjer til ræling-profil</b><br/>Pose med 6 stk bindeøjer, bolt og skive</p>   | 48.rp-b    |



## Snørekrog

|   | Betegnelse   | Varenummer |
|---|--|------------|
|  | <b>Snørekrog komplet for presenning</b><br>Galvaniseret stål, inkl. plastik bagplade for montering, pose med 10 sæt. | 110.sh     |

## Ståløje



|   | Betegnelse   | Varenummer |
|---|--|------------|
|   | <b>Ståløje for presenning</b><br>Ø13 x 26, pose med 20 stk.      | 110.se13   |
|  | <b>Ståløje for presenning</b><br>25/40 x 45/60, pose med 10 stk. | 110.oe20   |

## Gummistrop

|   | Betegnelse   | Varenummer |
|---|--|------------|
|  | <b>Gummistrop for presenning</b><br>285 x 30 mm, 4-huls, pose med 5 stk. | 110.rs     |

| Presenningsrem  |  |            |
|---|--|------------|
|   | Betegnelse   | Varenummer |
|  | <p><b>Presenningsrem komplet</b><br/>550 x 20 mm med kobberspænde, inkl. monteringsbagplade, pose med 5 sæt.</p> | 110.ps550  |

| Vridelukker  |  |            |
|--|--|------------|
|  | Betegnelse   | Varenummer |
|  | <p><b>Vridelukker for presenning</b><br/>Grå plastik, for oval øje, 20 x 40 mm, pose med 10 stk.</p> | 110.tb20   |

| Elastiksnor   |   |                 |
|---|---|-----------------|
|   | Betegnelse  | Varenummer      |
|  | <p><b>Elastiksnor til trailer presenninger</b><br/>Længde 7,3 m, inklusiv elastiksamlere.</p>             | 44.tcer730      |
|  | <p><b>Elastiksnor Pro</b><br/>100 m på rulle, Ø6 mm, hvid, pakket i pose, ekstra kraftig elasticitet.</p> | 44.tcer10000pro |

## Fjongknapper

|   | Betegnelse   | Varenummer           |
|---|--|----------------------|
|  | <b>Fjongknapper</b><br>Pose med 20 stk.<br>Kasse med 2000 stk. | 44.pb20<br>44.pb2000 |

## Klemringe

|   | Betegnelse  | Varenummer |
|---|---|------------|
|   | <b>Klemringe for 5 mm elastiksnor til presenning</b><br>sæt med 50 stk. | 44.sb50    |
|  | <b>Klemringe for 6 mm elastiksnor til presenning</b><br>sæt med 50 stk. | 44.sb50pro |

| Presenningsbøjler, aluminium  |  |               |
|---|--|---------------|
|   | Betegnelse   | Varenummer    |
|    | <p><b>Presenningsbøjle, lang</b><br/>                     Aluminium, vægt KUN 0,8 kg<br/>                     Justerbar fra 140 til 210 cm<br/>                     Passer til alle trailere<br/>                     Anbefalet 2 til 3 stk. (langsmonteret) pr. trailer</p>   | 55.152040-s   |
|    | <p><b>Presenningsbøjle, lang</b><br/>                     Med U-profil 36 mm<br/>                     Aluminium, vægt KUN 0,8 kg<br/>                     Justerbar fra 140 til 210 cm<br/>                     Passer til alle trailere<br/>                     Anbefalet 2 til 3 stk. (langsmonteret) pr. trailer</p> | 55.152040-u36 |
|  | <p><b>Presenningsbøjle, kort</b><br/>                     Aluminium, vægt KUN 0,6 kg<br/>                     Justerbar fra 100 til 145 cm<br/>                     Passer til alle trailere<br/>                     Anbefalet 3 til 4 stk. (tværmonteret) pr. trailer</p>  | 55.101460-s   |
|  | <p><b>Presenningsbøjle, kort</b><br/>                     Med U-profil 36 mm<br/>                     Aluminium, vægt KUN 0,6 kg<br/>                     Justerbar fra 100 til 145 cm<br/>                     Passer til alle trailere<br/>                     Anbefalet 3 til 4 stk. (tværmonteret) pr. trailer</p>  | 55.101460-u36 |
|  | <p><b>Forlængerrør for ovenstående</b><br/>                     Forlænger op til 1 meter<br/>                     Passer til kort og lang presenningsbøjle<br/>                     Vægt KUN 0,35 kg</p>   | 55.100300-s   |

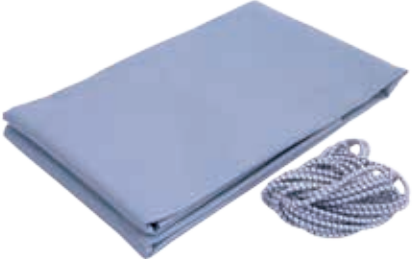

## Flad presenning til trailere

|   | Betegnelse  | Varenummer     |
|---|---|----------------|
|  <p>Farve: Grå</p> | <b>Presenning 151 x 101 x 7,5 cm</b><br>Inkl. 5 meter elastik PRO<br>Passer bl.a. til 1150S, Kippi 150                        | 44.tc27675-b   |
|   | <b>Presenning 213 x 124 x 7,5 cm</b><br>Inkl. 6,4 meter elastik PRO<br>Passer bl.a. til 1205 S/P, Kippi 200                   | 44.tc27676-b   |
|   | <b>Presenning 210 x 135 x 7,5 cm</b><br>Inkl. 7,0 meter elastik PRO<br>Passer bl.a. til 2205 S/P (indtil 2014)                | 44.tc27791-b   |
|   | <b>Presenning 210 x 135 x 7,5 cm</b><br>Inkl. 7,0 meter elastik PRO<br>Passer bl.a. til 2205 S/P, model 2015                  | 44.tc27791-m15 |
|   | <b>Presenning 209 x 116 x 7,5 cm</b><br>Inkl. 6,4 meter elastik PRO<br>Passer bl.a. til Basic                                 | 44.tc41253-b   |
|   | <b>Presenning 265 x 150 x 7,5 cm</b><br>Inkl. 8,1 meter elastik PRO<br>Passer bl.a. til Bravo 260 / 4260                      | 44.tc8559-b    |
|   | <b>Presenning 258 x 150 x 7,5 cm</b><br>Inkl. 8,1 meter elastik PRO<br>Passer bl.a. til 3251                                  | 44.tc28984-b   |
|   | <b>Presenning 266 x 135 x 7,5 cm</b><br>Inkl. 7,8 meter elastik PRO<br>Passer bl.a. til 2260 (indtil 2014)                    | 44.tc8552-b    |
|   | <b>Presenning 266 x 135 x 7,5 cm</b><br>Inkl. 8,1 meter elastik PRO<br>Passer bl.a. til 2260, model 2015                      | 44.tc8552-m15  |
|   | <b>Presenning 315 x 175 x 7,5 cm</b><br>Inkl. 9,9 meter elastik PRO<br>Passer bl.a. til Bravo 310 & 4310                      | 44.tc20027-b   |
|   | <b>Presenning 213 x 151 x 7,5 cm</b><br>Inkl. 7 meter elastik PRO<br>Passer bl.a. til 3205                                    | 44.tc28983-b   |
|   | <b>Presenning 211 x 116 x 8 cm</b><br>Inkl. 7 meter elastik<br>Passer bl.a. til Humbaur HA752111 og 102111                    | 44.tc21111680  |
|   | <b>Presenning 258 x 136 x 8 cm</b><br>Inkl. 8,4 meter elastik<br>Passer bl.a. til Humbaur HA752513 - 132513 - 152513 - 202513 | 44.tc25813680  |

| Højpresenninger   |  |                                    |
|---|--|------------------------------------|
|   | Betegnelse   | Varenummer                         |
|    | <p><b>Højpresenning, sæt inkl. stativ</b><br/>                     Trailer mål: 210 x 122 cm<br/>                     Højde stativ: 82 cm<br/>                     Materiale: PRO light kvalitet<br/>                     Passende for Brenderup Kippi 200 - 1205S</p>   | htc-fr210123a                      |
|    | <p><b>Højpresenning, sæt inkl. stativ</b><br/>                     Trailer mål: 209 x 134 cm<br/>                     Højde stativ: 109 cm<br/>                     Materiale: PRO kvalitet<br/>                     Passende for Brenderup 2205</p>   | htc-fr210135A                      |
|   | <p><b>Højpresenning, sæt inkl. stativ</b><br/>                     Trailer mål: 264 x 134 cm<br/>                     Højde stativ: 109 cm<br/>                     Materiale: PRO kvalitet<br/>                     Passende for Brenderup 2260, model 2015<br/>                     Passende for Brenderup 2260 (fremtil 2014)</p> | htc-fr265135a<br>htc-fr265135N     |
|  | <p><b>Højpresenning, sæt inkl. stativ</b><br/>                     Trailer mål: 257 x 137 cm<br/>                     Højde stativ: 114 cm<br/>                     Materiale: PRO kvalitet<br/>                     Passende for Humbaur HA132513<br/>                     Farve: Grå<br/>                     Farve: Mørkegrå</p>  | htc-fr257137aST<br>htc-fr257137aPP |
|  | <p><b>Højpresenning, sæt, inkl. stativ</b><br/>                     Trailer mål: 216 x 116 cm<br/>                     Højde stativ: 110 cm<br/>                     Materiale: PRO kvalitet<br/>                     Passende for Unsinn WEB10</p>  | htc-fr217117                       |
|  | <p><b>Højpresenning, sæt, inkl. stativ</b><br/>                     Trailer mål: 256 x 132 cm<br/>                     Højde stativ: 110 cm<br/>                     Materiale: PRO kvalitet<br/>                     Passende for Unsinn WEB14</p>  | htc-fr257133                       |

**Netsidepresenning**

|   | Betegnelse  | Varenummer                   |
|---|---|------------------------------|
|  | <p><b>Netsidepresenning</b><br/>                     Materiale: PRO light<br/>                     Størrelse: 213 x 124 x 57,5 cm<br/>                     Farve: Grå<br/>                     Inkl. elastik PRO, og gummistropper.<br/>                     Passer bl.a til 1205 S/P</p>   | 44.htc27676                  |
|  | <p><b>Netsidepresenning</b><br/>                     Materiale: PRO<br/>                     Størrelse: 268 x 135 x 57,5 cm<br/>                     Farve: Grå<br/>                     Inkl. elastik PRO, og gummistropper.<br/>                     Passer bl.a til 2260, model 2015<br/>                     Passer bl.a til 2260 (frem til 2014)</p> | 44.htc8552-m15<br>44.htc8552 |

**Trailernet**

|   | Betegnelse               | Varenummer   |
|---|--------------------------|--------------|
|  | Trailernet, 160 x 110 cm | 191.tn160110 |
|   | Trailernet, 210 x 120 cm | 191.tn210120 |
|   | Trailernet, 250 x 130 cm | 191.tn250130 |
|   | Trailernet, 250 x 160 cm | 191.tn250160 |
|   | Trailernet, 250 x 200 cm | 191.tn250200 |
|   | Trailernet, 280 x 160 cm | 191.tn280160 |
|   | Trailernet, 300 x 200 cm | 191.tn300200 |
|   | Trailernet, 300 x 250 cm | 191.tn300250 |
|   | Trailernet, 335 x 180 cm | 191.tn335180 |
|   | Trailernet, 350 x 200 cm | 191.tn350200 |
|   | Trailernet, 350 x 250 cm | 191.tn350250 |
|   | Trailernet, 405 x 180 cm | 191.tn405180 |
|   | Trailernet, 420 x 220 cm | 191.tn420220 |
|   | Trailernet, 440 x 220 cm | 191.tn440220 |
|   | Trailernet, 540 x 220 cm | 191.tn540220 |
| Trailernet, 800 x 350 cm  | 191.tn800350             |              |
| Trailernet, 900 x 400 cm  | 191.tn900400             |              |

*Trailernet sikrer lasten.  
 I kraftig kvalitet og flere størrelser.  
 Med kantsnor samt kraftig sort indsyet elastik  
 3 mm garntykkelse, 45 x 45 mm maskestørrelse*

| Stik / Adapter / Kabel  |   |                                   |
|---|---|-----------------------------------|
|   | Betegnelse  | Varenummer                        |
|    | <b>Stikdåse</b><br>7-polet, 12V<br>7-polet, 12V Pro ISO 1724  | 004017k<br>090147317              |
|    | <b>Stikdåse</b><br>13-polet, 12V med skruetilslutning<br>13-polet, 12V med skruetilslutning Pro inkl. gummidækning ISO 11446  | 004213k<br>090163402              |
|    | <b>Gummiafdækning</b><br>til 004017k & 004213k<br>til 090147317   | 006057k<br>090147921              |
|   | <b>Stik</b><br>7-polet, 12V med skueterminal<br>7-polet, 12V med skueterminal Pro ISO 1724  | 005117k<br>090147714              |
|  | <b>Adapter</b><br>13-polet til 7-polet<br>13-polet til 7-polet, 12V Pro ISO 11446/ISO 1724  | 005600k<br>090163817              |
|  | <b>Adapter</b><br>7-polet til 13-polet, 12V<br>7-polet til 13-polet, 12V Pro ISO 11446/ISO 1724   | 005604k<br>090163818              |
|  | <b>Stik</b><br>13-polet, 12V, Twist-On-Plug<br>13-polet, 12V, Twist-On-Plug Pro   | 005112k<br>090163602              |
|  | <b>Spiralkabel</b><br>7-polet, 12V, arbejdslængde 1,8 meter<br>7-polet, 12V, arbejdslængde 1,5 meter Pro ISO 1724<br>7-polet, 12V, arbejdslængde 3,5 meter Pro ISO 1724                                   | 2600.02<br>090180162<br>090182362 |
|  | <b>Spiralkabel</b><br>Stikpropper i ekstra høj kvalitet med højere modstandsdygtighed over for slag og stød<br>kabel Ø35 mm<br>7>13 polet, arbejdslængde 1,5 meter<br>7>13 polet, arbejdslængde 1,8 meter | 090180213<br>2600.01              |

## Lygtesæt - komplet med pærer







|   | Betegnelse  | Varenummer  |
|---|---|-------------|
|  | <b>Lygte/kabelsæt Aspöck Multipoint II</b><br>Består af 2 stk. Multipoint II lygter og 1 stk. 4 meter kabel.<br>Klar til montering på trailer. Med nummerpladelys indbygget i lygten. | 82-7027-011 |
|  | <b>Lygte/kabelsæt Aspöck Minipoint</b><br>Består af 2 stk. Minipoint lygter og 1 stk. 4 meter kabel.<br>Klar til montering på trailer. Med nummerpladelys indbygget i lygten.         | 82-1070-011 |

## Kabler

|   | Betegnelse   | Varenummer  |
|---|--|-------------|
|  | <b>Fordelerkabel, 2 meter, højre</b><br>Bajonet - 5 polet, grøn  | 66-1542-037 |
|  | <b>Fordelerkabel, 2 meter, venstre</b><br>Bajonet - 5 polet, gul                                       | 66-1544-097 |
|   | <b>Forlængerkabel, 2 meter, højre</b><br>6x0,75 mm kabel<br>med 8 polet bajonetstik "Open end" - grøn  | 66-2111-007 |
|   | <b>Forlængerkabel, 2 meter, venstre</b><br>6x0,75 mm kabel<br>med 8 polet bajonetstik "Open end" - gul | 66-2112-007 |

| Baglygter - komplette   |   |             |
|---|---|-------------|
|   | Betegnelse  | Varenummer  |
|    | <b>Baglygte, Aspöck Multipoint</b><br>Venstre, 12V, komplet med pærer og bajonetttilslutning.<br>Bag, brems, blink, tåge og nr. pladelys.     | 24-5000-007 |
|   | <b>Baglygte Aspöck Multipoint</b><br>Højre, 12V, komplet med pærer og bajonetttilslutning. Bag, brems, blink og nr. pladelys.                 | 24-5200-007 |
|    | <b>Baglygte, Aspöck Multipoint II</b><br>Venstre, 12V, komplet med pærer og bajonetttilslutning.<br>Bag, brems, blink, tåge og nr. pladelys.  | 24-7000-007 |
|   | <b>Baglygte Aspöck Multipoint II</b><br>Højre, 12V, komplet med pærer og bajonetttilslutning. Bag, brems, blink og nr. pladelys.              | 24-7200-007 |
|  | <b>Baglygte, Aspöck Multipoint III</b><br>Venstre, 12V, komplet med pærer og bajonetttilslutning.<br>Bag, brems, blink, tåge og nr. pladelys. | 24-8000-007 |
|   | <b>Baglygte Aspöck Multipoint III</b><br>Højre, 12V, komplet med pærer og bajonetttilslutning. Bag, brems, blink og nr. pladelys.             | 24-8200-007 |
|  | <b>Baglygte Aspöck Multipoint IV</b><br>Venstre, 12V, komplet med pærer og bajonetttilslutning.<br>Bag, brems, blink, tåge og nr. pladelys.   | 24-8400-007 |
|   | <b>Baglygte Aspöck Multipoint IV</b><br>Højre, 12V, komplet med pærer og bajonetttilslutning. Bag, brems, blink og nr. pladelys.              | 24-8600-007 |
|  | <b>Baglygte Minipoint 3-kammer</b><br>med bajonetstik og 12V pærer uden nummerpladelys.   | 23-0200-507 |
|   | <b>Baglygte Minipoint 3-kammer</b><br>med bajonetstik og 12V pærer med nummerpladelys.  | 23-0300-507 |

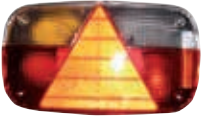
## Baglygteglas

|   | Betegnelse  | Varenummer  |
|---|---|-------------|
|    | <b>Baglygteglas</b><br>Minipoint 3-kammer               | 18-8300-007 |
|    | <b>Baglygteglas</b><br>Multipoint - Venstre             | 18-8450-007 |
|   | <b>Baglygteglas</b><br>Multipoint - Højre               | 18-8452-007 |
|  | <b>Baglygteglas</b><br>Multipoint II - Venstre & højre  | 18-8470-007 |
|  | <b>Baglygteglas</b><br>Multipoint III - Højre & venstre | 18-8480-007 |
|  | <b>Baglygteglas</b><br>Multipoint IV - Venstre          | 18-8484-007 |
|  | <b>Baglygteglas</b><br>Multipoint IV - Højre            | 18-8486-007 |



| Kuglekoblinger  |   |            |
|---|---|------------|
|   | Betegnelse  | Varenummer |
|    | <p><b>Kuglekobling, EM80V E</b><br/>                     Tilladt totalvægt: 800 kg<br/>                     Max støttelast: 75 kg<br/>                     Trækstangsdiameter: □ 50 x 50 mm<br/>                     For trækstang</p>    | 5250       |
|    | <p><b>Kuglekobling, EM80V F</b><br/>                     Tilladt totalvægt: 800 kg<br/>                     Max støttelast: 75 kg<br/>                     Trækstangsdiameter: □ 60 x 60 mm<br/>                     For trækstang</p>    | 5260       |
|   | <p><b>Kuglekobling, EM150R A</b><br/>                     Tilladt totalvægt: 1500 kg<br/>                     Max støttelast: 100 kg<br/>                     Trækstangsdiameter: Ø45/46 mm<br/>                     For påløbsbremse</p> | 5345       |
|  | <p><b>Kuglekobling, EM150R B</b><br/>                     Tilladt totalvægt: 1500 kg<br/>                     Max støttelast: 100 kg<br/>                     Trækstangsdiameter: Ø50/51 mm<br/>                     For påløbsbremse</p> | 5350       |
|  | <p><b>Kuglekobling, EM300R A</b><br/>                     Tilladt totalvægt: 3000 kg<br/>                     Max støttelast: 150 kg<br/>                     Trækstangsdiameter: Ø45/46 mm<br/>                     For påløbsbremse</p> | 5645       |
|  | <p><b>Kuglekobling, EM300R B</b><br/>                     Tilladt totalvægt: 3000 kg<br/>                     Max støttelast: 150 kg<br/>                     Trækstangsdiameter: Ø50/51 mm<br/>                     For påløbsbremse</p> | 5650       |





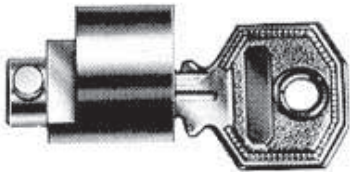

| Stabilisatorkobling   |  |                |
|---|--|----------------|
|   | Betegnelse   | Varenummer     |
|    | <b>Stabilisatorkobling BPW</b><br>Godkendt til anhængere op til 3 ton<br>Kan monteres på trækrør Ø35-50 mm   | 05.803.13.39.0 |
|    | <b>Stabilisatorkobling Winterhoff WS3000 S-D</b><br>Vægt: 5,78 kg<br>Godkendt til anhængere op til 3 ton<br>med et kugletryk på 150 kg.<br>Kan monteres på trækrør Ø35/40/45/46/50 | 1450           |
|  | <b>Frikationsbelægning</b><br>for WS3000 - 1450  | 6205           |
|  | <b>Håndtag</b><br>For kobling WS3000 (fra 08-2002) inkl. bremseklodser,<br>bolte samt monteringsvejledning   | 6213           |
|  | <b>Tilkoblingsviser, for WS3000</b><br>(fra 08-2009)   | 6202           |

| Robstoplåse   |  |            |
|---|--|------------|
|   | Betegnelse   | Varenummer |
|  | <b>Robstoplås for stabilisatorkobling WS3000S-D</b><br>varenr. 1450, Ø15 mm  | 1551       |
|  | <b>Robstoplås for stabilisatorkobling WS3000S-D</b><br>varenr. 1450, fremstillet i hærdet stål, Ø19 mm<br>Godkendt med SCM/SSF certifikater. | 1553       |

| Trailerlåse   |  |            |
|---|--|------------|
|   | Betegnelse   | Varenummer |
|    | <p><b>Trailerlås, Safety-Lock</b></p> <p>Kan anvendes både, når traileren er parkeret, og når traileren er koblet på bilen</p> <p>Passer på de fleste kuglekoblinger</p> <p>Inkl. hængelås</p> <p>Mønsterbeskyttet (DK nr. DR2003 00228)</p>   | 55sl-2     |
|    | <p><b>Hængelås til kuglekoblinger</b></p> <p>Kan anvendes ved både på- og afkoblet påhængsvogn.</p> <p>Kan bruges til direkte montering på mange typer kuglekoblinger med gennemgående hul minimum Ø10 mm og bredde max 70 mm</p> <p>Passer desuden til Safety-Lock og andre lignende låse</p> | 55.lsl-1   |
|  | <p><b>Trailerlås PRO Safety-Lock</b></p> <p>Universal kasselås - inkl. diskulås</p> <p>Passer på de fleste kuglekoblinger</p>  | 55.psl-02  |
|  | <p><b>Trailerlås, PRO Safety-Lock</b></p> <p>Universal kasselås - inkl. diskulås</p> <p>Passer på de fleste kuglekoblinger</p> <p>Pakket i kasse</p>   | 55.psl-03  |





| Trailerlåse   |  |            |
|---|--|------------|
|   | Betegnelse   | Varenummer |
|    | <b>Diskoslås til PRO Safety-Lock</b><br>Vare nr. 55.psl-02 og andre lignende låse. | 3301       |
|   | <b>Stiklås</b><br>for EM80R/150R/220R  | 2121       |
|  | <b>Stiklås</b><br>for EM300R/350R  | 2122       |
|  | <b>Tyverisikringslås</b><br>for Albe kuglekoblinger med låsehul i håndgreb         | 2123       |





## Støttehjul

|   | Betegnelse  | Varenummer  |
|---|---|-------------|
|    | <b>Støttehjul PRO</b><br>Fastgummihjul 200 x 50 mm<br>Yderrør: Ø48 mm<br>Belastning: 150 kg<br>Med trykleje<br>Håndtag 121° vinkel        | 207.stmp-02 |
|   | <b>Fastgummihjul for støttehjul</b>   | 119.str-02  |
|   | <b>Støttehjul PRO</b><br>Fastgummihjul 220 x 65 mm<br>Yderrør: Ø48 mm<br>Med regntæt gummilåg i top<br>Belastning: 180 kg<br>Med trykleje | 207.stmp-08 |
|  | <b>Støttehjul PRO</b><br>Luftgummihjul 260 x 85 mm stålfælg, med butylslange<br>Yderrør: Ø48 mm<br>Belastning: 150 kg<br>Med trykleje     | 207.stlp-02 |
|   | <b>Håndtag for støttehjul</b><br>90° vinkel   | 119.str-01  |
|  | <b>Støttehjul PRO</b><br>Fastgummihjul 220 x 65 mm<br>Yderrør: Ø60 mm<br>Højde yderrør: 390 mm<br>Belastning: 250 kg<br>Med trykleje      | 207.stmp-07 |
|   | <b>Håndtag for støttehjul</b>   | 119.str-03  |
|   | <b>Fastgummihjul for støttehjul</b>   | 119.str-04  |

| Støttehjul  |   |             |
|---|---|-------------|
|   | Betegnelse  | Varenummer  |
|    | <p><b>Støttehjul PRO</b><br/>                     Fastgummihjul 220x65 mm<br/>                     Yderrør: Ø60 mm<br/>                     Højde yderrør: 530 mm<br/>                     Belastning: 400 kg<br/>                     Med trykleje og smørenippel</p>  | 119.stmp-04 |
|   | <p><b>Støttehjul PRO, med riller</b><br/>                     Fastgummihjul 200 x 60 mm<br/>                     Yderrør: Ø48 mm<br/>                     Belastning: 180 kg<br/>                     Med trykleje</p>  | 207.stmp-06 |
|  | <p><b>Støttehjul PRO, klapbart</b><br/>                     Fastgummihjul 200 x 60 mm<br/>                     Yderrør: Ø60 mm, med beslag type "B"<br/>                     Belastning: 200 kg</p>   | 207.stfo-01 |
|  | <p><b>Støttehjul PRO, vægtindikator 0-125 kg</b><br/>                     Massivgummihjul 215 x 70 mm, med kunststoffælg<br/>                     Yderrør: Ø48 mm<br/>                     Belastning: 150 kg<br/>                     Med trykleje<br/>                     Til måling af støttelast på anhængertrækket.<br/>                     Kan problemfrit erstatte almindelige støttehjul.</p> | 207.stmp-05 |

## Støttebensæt



|   | Betegnelse   | Varenummer  |
|---|--|-------------|
|    | <b>Støtteben</b><br>Trailerkit<br>Længde: 700 mm<br>Med bøjlegreb af stål og 2 stk. klembøjler.          | 207.stb700  |
|    | <b>Støtteben</b><br>Trailerkit<br>Længde: 1000 mm<br>Med bøjlegreb af stål og 2 stk. klembøjler.         | 119.stb1000 |
|  | <b>Støtteben for opdrejning med fast fod</b><br>Opdrejningshøjde: 450 mm<br>Støttelast: 1800 kg          | 207.stcv-01 |
|  | <b>Drejbart støtteben, Ø56</b><br>Opdrejningshøjde 25 cm<br>Belastning 1500 kg, inklusiv monteringsplade | 207.stb-01  |

| Klembøjler  |   |             |
|---|---|-------------|
|   | Betegnelse  | Varenummer  |
|    | <b>Klembøjle</b><br>For rør Ø48 mm                                    | 207.kh-01   |
|    | <b>Klembøjle</b><br>For rør Ø48 mm<br>6-huls med støbt bagplade       | 207.khhd-02 |
|  | <b>Klembøjle</b><br>For rør Ø48 mm<br>støbt for støttehjul med ribber | 207.khhd-03 |
|  | <b>Klembøjle</b><br>For støttehjul med yderrør Ø60 mm                 | 207.kh60    |



## Komplette hjul

|   | Betegnelse   | Varenummer        |
|---|--|-------------------|
|    | <b>Hjul, 4.00x8/4, 4/60/100</b><br>Indpresning: ET0, Index: 62M<br>Belastning: 265 kg, Hastighed: 130 km/t       | TR8400soelv-001   |
|    | <b>Hjul, 5.00-10/4, 4/60/100</b><br>Indpresning: ET0, Index: 72N<br>Belastning: 355 kg, Hastighed: 140 km/t      | 0064094           |
|  | <b>Hjul, 145-10/6, 4/60/100</b><br>Indpresning: ET0, Index: 76M<br>Belastning: 400 kg, Hastighed: 130 km/t       | TR10145soelv-001K |
|  | <b>Hjul, 155R13C-8, 4/57/100</b><br>Indpresning: ET30, Index: 90/88S<br>Belastning: 600 kg, Hastighed: 180 km/t  | 200.13155-2       |
|  | <b>Hjul, 185R14C-8, 5/67/112</b><br>Indpresning: ET30, Index: 102/100<br>Belastning: 850 kg, Hastighed: 160 km/t | 200.14185-1       |

| Reservehjulstilbehør  |  |                |
|---|--|----------------|
|   | Betegnelse   | Varenummer     |
|  | <b>Reservehjulsovertræk 13" - 14"</b><br>Med pvc overflade og elastiske sider.<br>OBS - Passer til max diameter på hjul = 610 mm | 110.swc-01     |
|   | <b>Reservehjulsovertræk 14"</b><br>Med pvc overflade og elastiske sider.<br>OBS - Passer til max diameter på hjul = 645 mm       | 110.swc-01     |
|  | <b>Reservehjulsholder</b><br>Vangeafstand: 1441-2000 mm<br>Hjul: fleste 13, 14 og 15 tommer                                      | 05.189.30.87.0 |

| Stopklods for lette påhængsvogne/-køretøjer   |   |            |
|---|---|------------|
|   | Betegnelse  | Varenummer |
|  | <b>Stopklods, 200 x 120 mm</b><br>For fælg størrelse 10" til 14".<br>Vægt 1,75 kg | 42.62202   |

| Langnøgle for campingvogns-støtteben  |  |            |
|---|--|------------|
|   | Betegnelse   | Varenummer |
|  | <b>Langnøgle til AKU-boremaskine</b><br>For op- og nedskruining af campingvogns-støtteben,<br>nøglevidde 19 mm, længde 500 mm, gulchromatiseret. | 48.ht-01   |





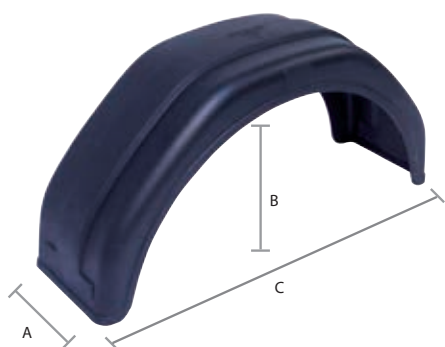

## Skærme



| Betegnelse           | A   | B   | C    | Varenummer  |
|----------------------|-----|-----|------|-------------|
| Skærm, sort - 10"    | 200 | 330 | 680  | 1011 20 111 |
| Skærm, sort - 12-13" | 200 | 390 | 750  | 1011 20 121 |
| Skærm, sort - 13-14" | 220 | 415 | 800  | 1011 21 131 |
| Skærm, sort - 14"    | 240 | 415 | 800  | 1011 23 131 |
| Boogieskærm, sort    | 220 | 380 | 1550 | 1031 21 201 |
| Boogieskærm, sort    | 240 | 380 | 1550 | 1031 23 201 |



## Værktøjskasse

|  | Betegnelse  | Varenummer |
|--|---|------------|
|  | <b>Værktøjskasse med lås, Forzaline</b><br>Farve: sort<br>Låge: Åbnes sidehængt<br>max. udvendig mål:<br>Længde: 550 mm<br>Bredde: 250 mm<br>Højde: 294 mm<br>Vægt: 2,5 kg<br>Indhold: 23 Liter | 208.tbp-2  |
|  | <b>Monteringsbeslag for værktøjskasse</b><br>4 stk. vinkelbeslag inkl. bolte, møtrikker og skiver   | 208.tbp-m  |

| Hængsler og Hægtelukker   |   |            |
|---|---|------------|
|   | Betegnelse  | Varenummer |
|    | <b>Hængseltap</b><br>112 x 77 mm, galvaniseret  | 6510472    |
|    | <b>Hængselleje</b><br>77 x 25 mm, galvaniseret  | 6510481    |
|   | <b>Hægtelukker</b><br>223 x 88 mm, med øje til hængelås, galvaniseret   | 42.hl-01   |
|  | <b>Krumjern</b><br>144 x 35 mm, galvaniseret  | 42.khl-01  |
|  | <b>Hægtelukker med sikringspal</b><br>Galvaniseret<br>Højde: 34 mm<br>Brede: 88 mm<br>Totallængde : 250-285 mm<br>Armlængde: 175 mm | 119.el-1   |
|  | <b>Hægtelukker med sikringspal</b><br>Kort model, galvaniseret  | 119.el-2   |

| Vinkellukkere   |   |              |
|---|---|--------------|
|   | Betegnelse  | Varenummer   |
|    | <b>Vinkellukker</b><br>175 x 105 mm, galvaniseret<br>Udformet som et 7-tal  | 3990-00-2100 |
|    | <b>Vinkellukker</b><br>175 x 105 mm, galvaniseret<br>Udformet som et omvendt 7-tal  | 3990-00-2200 |
|   | <b>Øje for vinkellukker</b><br>90 x 50 mm, galvaniseret   | 3520-00-6000 |
|  | <b>Vinkellukker</b><br>200 x 125 mm, galvaniseret<br>Udformet som et 7-tal  | 3991-00-2130 |
|  | <b>Vinkellukker</b><br>200 x 125 mm, galvaniseret<br>Udformet som et omvendt 7-tal  | 3991-00-2230 |
|  | <b>Vinkellukker, 6121N, højre</b><br>For påbygning<br>Udførelse: Galvaniseret<br>Udformet som et 7-tal                                | 6020142      |
|  | <b>Vinkellukker, 6121N, venstre</b><br>For påbygning<br>Udførelse: Galvaniseret<br>Udformet som spejlvendt 7 tal<br>Byggehøjde: 26 mm | 6020143      |

## BPW bowdenkabel

| L (mm) | L1 (mm) | D1 (mm) | D2 (mm) | Varenummer uden smørenippel | Varenummer med smørenippel |
|--------|---------|---------|---------|-----------------------------|----------------------------|
| 630    | 855     | M8      | 23,3    | 05.089.33.75.0              | 05.089.80.50.0             |
| 730    | 955     | M8      | 23,3    | 05.089.33.77.0              | 05.089.80.51.0             |
| 830    | 1055    | M8      | 23,3    | 05.089.33.78.0              | 05.089.80.52.0             |
| 930    | 1155    | M8      | 23,3    | 05.089.33.80.0              | 05.089.80.53.0             |
| 1030   | 1255    | M8      | 23,3    | 05.089.33.81.0              | 05.089.80.54.0             |
| 1130   | 1355    | M8      | 23,3    | 05.089.33.83.0              | 05.089.80.55.0             |
| 1230   | 1455    | M8      | 23,3    | 05.089.33.84.0              | 05.089.80.56.0             |
| 1330   | 1555    | M8      | 23,3    | 05.089.33.85.0              | 05.089.80.57.0             |
| 1430   | 1675    | M8      | 23,3    | 05.089.33.86.0              | 05.089.80.58.0             |
| 1530   | 1755    | M8      | 23,3    | 05.089.33.87.0              | 05.089.80.59.0             |
| 1630   | 1875    | M8      | 23,3    | 05.089.33.88.0              | 05.089.80.60.0             |

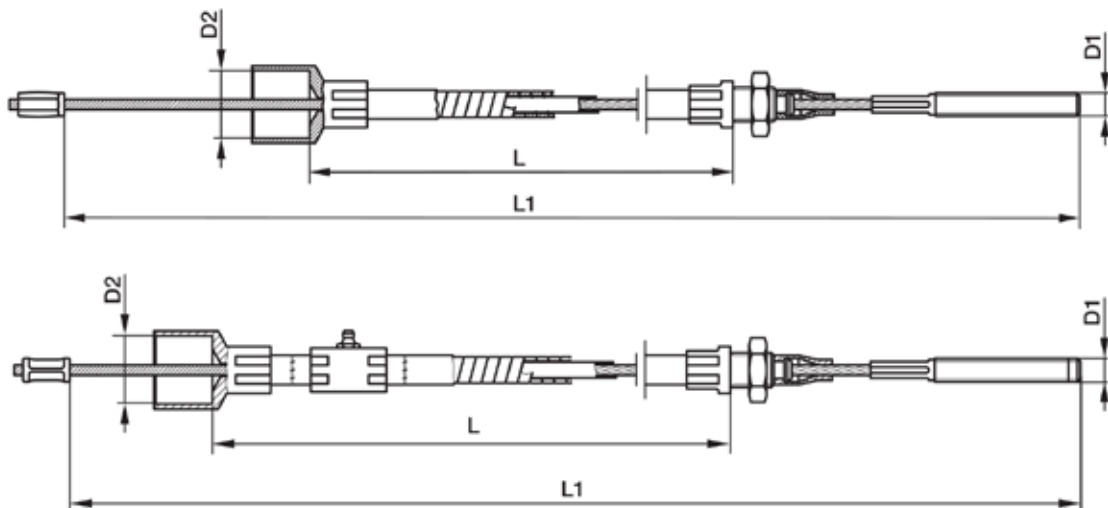

## Knott bowdenkabel

| L<br>(mm) | L1<br>(mm) | D1<br>(mm) | D2<br>(mm) | Varenummer     |
|-----------|------------|------------|------------|----------------|
| 430       | 640        | M8         | 18,5       | 05.089.33.31.0 |
| 530       | 740        | M8         | 18,5       | 05.089.33.32.0 |
| 630       | 840        | M8         | 18,5       | 05.089.33.33.0 |
| 650       | 840        | M8         | 18,5       | 05.089.33.34.0 |
| 730       | 940        | M8         | 18,5       | 05.089.33.36.0 |
| 830       | 1040       | M8         | 18,5       | 05.089.33.37.0 |
| 930       | 1140       | M8         | 18,5       | 05.089.33.39.0 |
| 1030      | 1240       | M8         | 18,5       | 05.089.33.41.0 |
| 1130      | 1340       | M8         | 18,5       | 05.089.33.43.0 |
| 1230      | 1440       | M8         | 18,5       | 05.089.33.44.0 |
| 1330      | 1540       | M8         | 18,5       | 05.089.33.45.0 |
| 1430      | 1640       | M8         | 18,5       | 05.089.33.46.0 |
| 1530      | 1740       | M8         | 18,5       | 05.089.33.47.0 |
| 1630      | 1840       | M8         | 18,5       | 05.089.33.48.0 |
| 2030      | 2240       | M8         | 18,5       | 218.33921124   |

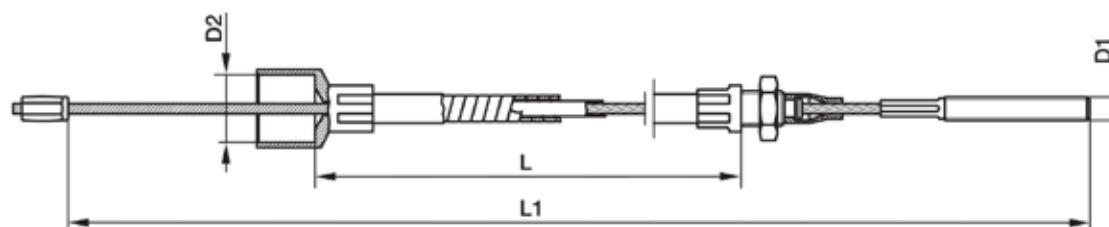

## AL-KO bowdenkabel

| L (mm) | L1 (mm) | D1 (mm) | D2 (mm) | Varenummer  |
|--------|---------|---------|---------|-------------|
| 770    | 966     | kugle   | 23      | 2509.247283 |
| 890    | 1066    | kugle   | 23      | 2509.247284 |
| 1020   | 1216    | kugle   | 23      | 2509.247285 |
| 1130   | 1330    | kugle   | 23      | 99036       |
| 1320   | 1516    | kugle   | 23      | 2509.247287 |
| 1430   | 1626    | kugle   | 23      | 2509.247288 |

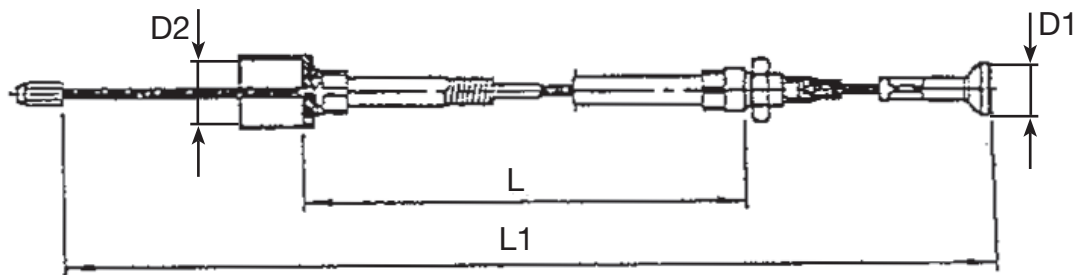



## Peitz bowdenkabel

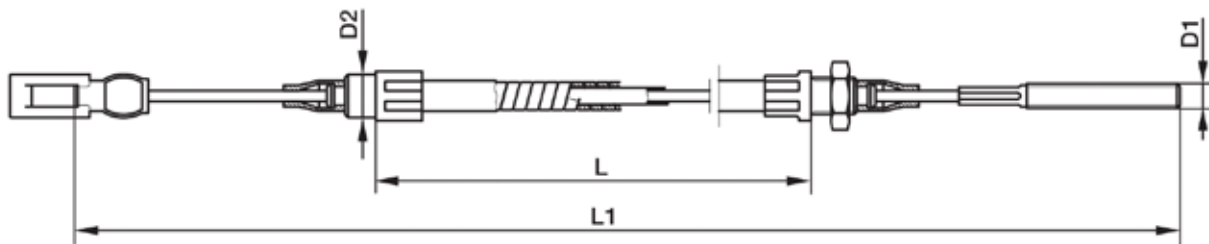

| L<br>(mm) | L1<br>(mm) | D1<br>(mm) | D2<br>(mm) | Varenummer     |
|-----------|------------|------------|------------|----------------|
| 800       | 1095       | M8         | 14         | 05 089 03 22 0 |
| 900       | 1195       | M8         | 14         | 05 089 03 23 0 |
| 1000      | 1295       | M8         | 14         | 05 089 03 24 0 |
| 1100      | 1395       | M8         | 14         | 05 089 03 25 0 |
| 1175      | 1470       | M8         | 14         | 05 089 03 26 0 |
| 1525      | 1820       | M8         | 14         | 05 089 03 27 0 |
| 1300      | 1595       | M8         | 14         | 05 089 03 28 0 |



| Kugleleje   |             |                 |                 |              |            |
|---|-------------|-----------------|-----------------|--------------|------------|
|   | Betegnelsen | Udv. dia.<br>mm | Indv. dia<br>mm | Bredde<br>mm | Varenummer |
|    | 6003        | 35              | 17              | 10           | 65133      |
|    | 6004        | 42              | 20              | 12           | 6004-K     |
|   | 6005        | 47              | 25              | 12           | W005074    |
|  | 6203        | 40              | 17              | 12           | 65204      |
|  | 6204        | 47              | 20              | 14           | 65215      |
|  | 6205        | 52              | 25              | 15           | 65216      |
|  | 6206        | 62              | 30              | 16           | 6206-2RS   |

## Rulleleje

|   | Betegnelse | Udv. dia.<br>mm | Indv. dia<br>mm | Bredde<br>mm | Varenummer    |
|---|------------|-----------------|-----------------|--------------|---------------|
|    | 30203      | 40              | 17              | 12           | 65416         |
|    | 30204      | 47              | 20              | 14           | 65417         |
|   | 30205      | 52              | 25              | 15           | 65418         |
|  | 32006      | 55              | 30              | 17           | 02.6404.30.00 |
|  | 30206      | 62              | 30              | 16           | 65419         |
|  | 32007      | 62              | 35              | 18           | 02.6404.35.00 |
|  | 30207      | 72              | 35              | 18,5         | 65420         |

| Dobbelt kugleleje   |   |                 |                 |              |                |
|---|---|-----------------|-----------------|--------------|----------------|
|   | Betegnelse  | Udv. dia.<br>mm | Indv. dia<br>mm | Bredde<br>mm | Varenummer     |
|    | Dobbeltleje sæt<br>passer til AL-KO   | 60              | 30              | 37           | 63000          |
|    | Dobbeltleje sæt,<br>for ECO   | 64              | 34              | 37           | 02.6450.02.00a |
|    | Dobbeltleje sæt,<br>for ECO   | 72              | 39              | 37           | 02.6450.13.00a |
|  | Dobbeltleje   | 72              | 39              | 37           | 2509.w397237   |
|  | Lukket dobbelt<br>kugleleje passer til<br>Ifor Williams<br>Belastning op til<br>2500kg. trailere        | 76              | 42              | 39           | 99141          |
|  | Lukket dobbelt<br>rulleleje for<br>Ifor Williams<br>fra 2500kg<br>Belastning op til<br>3500kg. trailere | 76              | 42              | 39           | 99142          |
|  | Dobb. kugleleje,<br>for Eco nav<br>til 1800kg   | 78              | 42              | 45           | 02.6450.15.00  |
|  | Dobbeltleje passer<br>til AL-KO   | 80              | 42              | 42           | 2509.w428042   |

## Lejekitsæt





|   | Betegnelse   | Varenummer     |
|---|--|----------------|
|    | <b>Lejekitsæt</b><br>(leje 30204/leje 30206/tætningsr.09.803.06.88.0/<br>kronmøtrik/split/navkapsel) | 05 805 00 01 0 |
|    | <b>Lejekitsæt</b><br>(leje 30205/leje 32007/tætningsring/kronmøtrik/split/<br>navkapsel)             | 05.805.01.03.0 |
|   | <b>Lejekitsæt</b><br>(leje 32008/leje 320 28/stålring/kronmøtrik/split/navkapsel)                    | 09.801.03.72.0 |
|  | <b>Lejekitsæt</b><br>(leje 30204/leje 32006/tætningsr.02.5661.20.00/<br>kronmøtrik/split/navkapsel)  | 09.805.02.04.0 |
|  | <b>Lejekitsæt</b><br>(KLM11749/710 og KLM45449/410 samt tætningsring)                                | 1637s          |
|  | <b>Lejekitsæt</b><br>(KLM11949/910 og KLM67048/010 samt tætningsring)                                | 2051s          |

| Tætningsringe   |                                    |              |              |           |                |
|---|------------------------------------|--------------|--------------|-----------|----------------|
|   | Betegnelse                         | Udv. dia. mm | Indv. dia mm | Bredde mm | Varenummer     |
|    | Tætningsring                       | 52           | 40           | 7         | 2509.701511    |
|    | Fey-tætning f/6204/6205 (u/læbe)   | 52           | 24           | 7         | 02.5681.92.00  |
|    | Fey-tætning f/30203/30205 (m/læbe) | 52           | 24           | 10        | 10 30 974397   |
|   | Tætningsring (t/bpw-løbeaksel)     | 55           | 38           | 7         | 02.5661.20.00  |
|  | Tætning Knott                      | 56           | 43,5         | 7         | 218.401110.001 |
|  | Fey-tætning f/R234-76 (m/læbe)     | 61,6         | 35           | 7         | 02.5681.95.00  |
|  | Tætningsring                       | 62           | 42           | 7         | rala817-3      |
|  | Fey-tætning f/30204/30206 (m/læbe) | 63           | 29           | 11        | 02.5681.04.00  |
|  | Tætning (3-delt)                   | 63           | 30           | 10        | 09.803.06.88.0 |
|  | Fey-tætning f/32008x32028 (m/læbe) | 68           | 40           | 8         | 02.5681.93.00  |

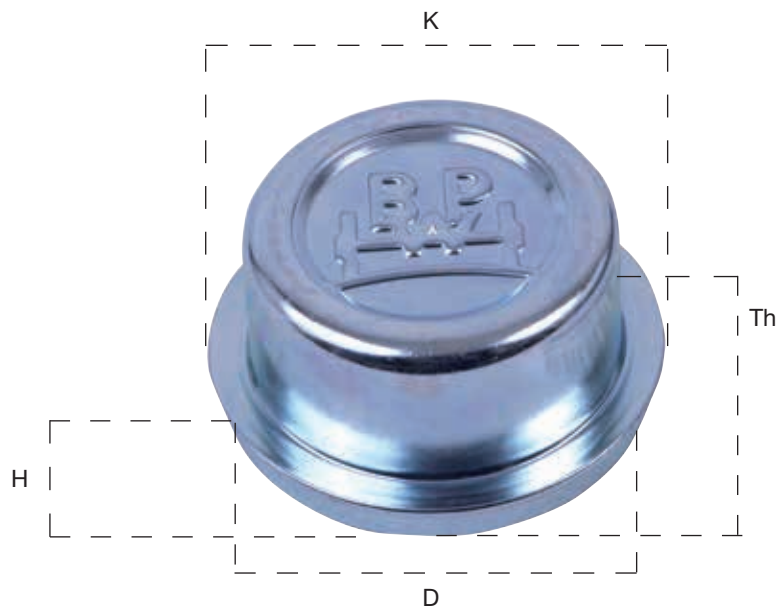
Navkapsel





| Description             | Diameter (D) | Højde (H) | Kravens diameter (K) | Total højde (Th) | Varenummer     |
|-------------------------|--------------|-----------|----------------------|------------------|----------------|
| Navkapsel BPW           | 48           | 8         | 54                   | 23               | 03.211.01.08.0 |
| Navkapsel BPW           | 50,5         | 9         | 55                   | 29               | 03.211.01.11.0 |
| Navkapsel Knott         | 52           | 7         | 56                   | 26               | 218.47117      |
| Navkapsel BPW           | 53           | 10        | 58                   | 32               | 03.211.02.02.0 |
| Navkapsel Knott         | 64           | 7         | 68                   | 26               | 218.47151      |
| Navkapsel BPW           | 64,5         | 6         | 69                   | 34               | 03.211.03.07.0 |
| Navkapsel Ifor Williams | 76,5         | 12        | 81                   | 30               | 37790          |



| Bremsebakkekit komplet for én aksel   |  |                                |
|---|--|--------------------------------|
|   | Betegnelse   | Varenummer                     |
|    | <b>BPW S1704-7 RASK</b><br>170 x 40 mm                                     | 09 801 03 82 0                 |
|    | <b>BPW S 2005-7 RASK</b><br>200 x 50 mm                                    | 09 801 03 79 0                 |
|  | <b>PEITZ R 234-76</b><br>230 x 40 mm                                       | 09 801 03 76 0                 |
|  | <b>PEITZ R 160-76</b><br>160 x 35 mm                                       | SBA828-4                       |
|  | <b>BPW / KNOTT S1635-6</b><br>160 x 35 mm<br><br>Original<br><br>Uoriginal | 218.402611.001<br><br>SBA836-4 |



**Bremsebakkekit komplet for én aksel**

|   | Betegnelse   | Varenummer                            |
|---|--|---------------------------------------|
|    | <p><b>BPW / KNOTT S 2005-5 RASK</b><br/>200 x 50 mm</p> <p>Original</p> <p>Uoriginal</p> | <p>218.47276</p> <p>SBA837-4S</p>     |
|    | <p><b>KNOTT 250x40</b></p> <p>Original</p> <p>Uoriginal</p>                              | <p>218.402677.001</p> <p>SBA839-4</p> |
|  | <p><b>AL-KO 1635/1636/1637</b><br/>160 x 35 mm</p> <p>Original</p> <p>Uoriginal</p>      | <p>2509.1213888</p> <p>SBA818-4</p>   |
|  | <p><b>AL-KO 2050/2051</b><br/>200 x 50 mm</p> <p>Original</p> <p>Uoriginal</p>           | <p>2509.1213889</p> <p>SBA817-4</p>   |
|  | <p><b>AL-KO Bremsebakkesæt, 2360-2361</b></p> <p>Original</p>                            | <p>2509.1213890</p>                   |

| ALKO dele til påløb   |  |               |
|---|--|---------------|
|   | Betegnelse   | Varenummer    |
|    | Støddæmper 90S 1-2-3 & 101/102VB                     | 2509.366348   |
|    | Støddæmper 161S fra 10/92, 505mm                     | 2509.370556   |
|  | Støddæmper 251S fra 10/92, 505mm                     | 2509.370589   |
|  | Støddæmper 2,8VB                                     | 2509.21726604 |
|  | Gasfjeder til håndbremsegreb 2,8VB, 251VB, 252VB, 35 | 2509.603896   |

## ALKO dele til påløb

|   | Betegnelse  | Varenummer       |
|---|---|------------------|
|    | <b>Gummibælg</b><br>30S, 90S, 250S, 101VB, 1,3VB, 2,0VB     | 2509.2073890210  |
|    | <b>Gummibælg</b><br>161S/251S - Ø50                         | 2509.366356      |
|  | <b>Gummibælg</b><br>2,8VB, 351VB, 352VB, 55/70mm            | 2509.21726600003 |
|  | <b>Glidbøsningssæt</b><br>firkant hvid, 90S/3 firkant       | 2509.1210678     |
|  | <b>Glidbøsningssæt</b><br>rund sort, 60S, 90S, 120SR-B rund | 2509.1210679     |

## BPW / ZAF -1 (m/integreret støddæmper i håndbremsegreb)

| Nr. på påløbet |                       | 48.25.58x.xxx  | 48.29.58x.xxx  | 48.36.58x.xxx  | 48.44.58x.xxx  |
|----------------|-----------------------|----------------|----------------|----------------|----------------|
|                |                       | ZAF 1,35-1     | ZAF 1,6-1      | ZAF 2,0-1      | ZAF 2,8-1      |
| 441            | Kuglekobling          | 5345           | 5345           | 5545           | 5650           |
| 442b           | Trykstang             | 05 399 69 16 0 | 05 399 69 11 0 | 05 399 69 11 0 | 05 399 69 17 0 |
| 443            | Støddæmper            | 02.3722.27.01  | 02.3722.52.01  | 02.3722.25.01  | 02.3722.43.00  |
| 449            | Gummibælg             | 03.130.09.11.0 | 03.130.09.11.0 | 03.130.09.11.0 | 03.130.08.18.0 |
| 451            | Glidebøsning Forreste | 03.030.13.13.0 | 03.030.13.13.0 | 03.030.13.13.0 | 03.030.13.14.0 |
| 452            | Glidebøsning Bageste  | 03.030.12.96.0 | 03.030.12.96.0 | 03.030.12.96.0 | 03.030.13.10.0 |
| 455            | Smørenippel           | 02.6850.22.00  | 02.6850.22.00  | 02.6850.22.00  | 02.6850.20.00  |
| 461            | Afstandsbøsning       | 03.302.21.75.0 | 03.302.21.75.0 | 03.302.21.75.0 | 03.302.21.75.0 |
| 465            | Afslutningsdæksel     | 03.211.02.04.0 | 03.211.02.04.0 | 03.211.02.04.0 | 03.211.02.04.0 |
| 490            | Håndbremsegreb        | 05.203.03.46.0 | 05.203.03.46.0 | 05.203.03.47.0 | 05.203.03.48.0 |
| 497            | Sikkerhedswire        | 102.46022      | 102.46022      | 102.46022      | 102.46022      |
| 521            | Udvekslingsled / KH   | 05.190.39.35.0 | 05.190.39.35.0 | 05.190.39.32.0 | 05.190.39.32.0 |
| 524            | Gaffelstykke          | 05 171 50 06 0 | 03.171.02.41.0 | 03.171.02.41.0 | 03.171.02.41.0 |
| 526            | Bolt til gaffelstykke |                | 02.5850.26.02  | 02.5850.26.02  | 02.5850.26.02  |
| 527            | Sikringslås for bolt  |                | 02.3301.04.02  | 02.3301.04.02  | 02.3301.04.02  |

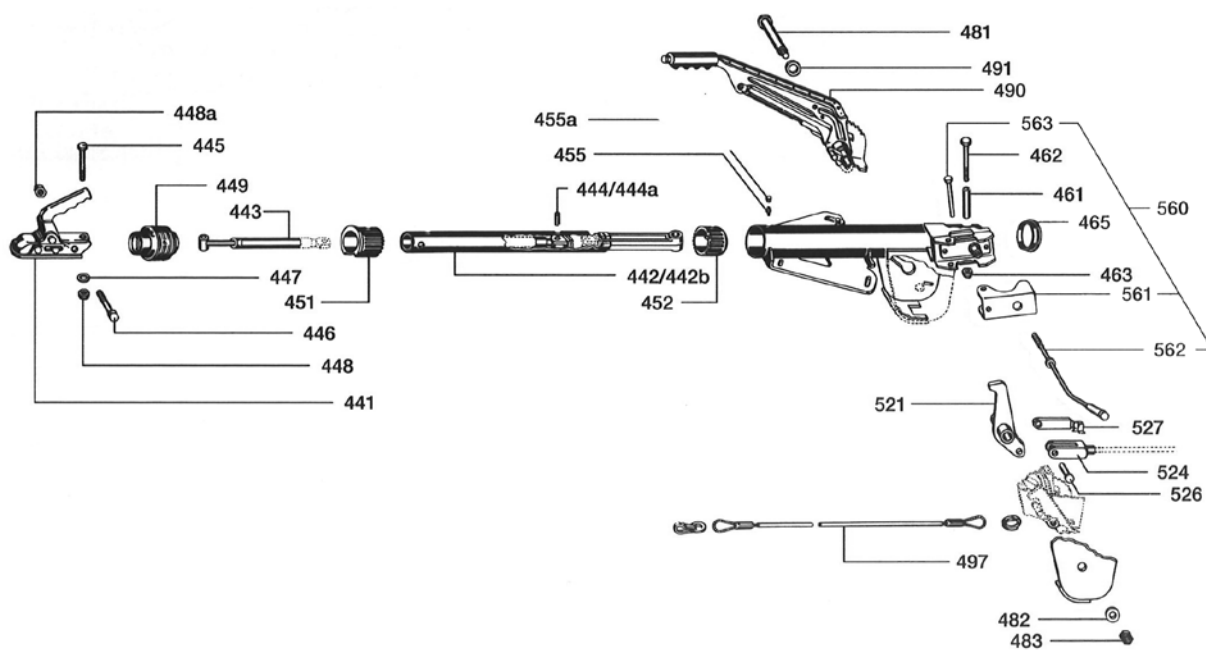

**BPW / ZAF -1 (m/fjederbøsning bag håndbremsegreb)**

| Nr. på påløbet |                              | 48.27.58x.xxx  | 48.36.58x.xxx  | 48.44.58x.xxx  |
|----------------|------------------------------|----------------|----------------|----------------|
|                |                              | ZAF 1,6-1      | ZAF 2,0-1      | ZAF 2,8-1      |
| 441            | Kuglekobling                 | 5545           | 5545           | 5650           |
| 442b           | Trykstang                    | 05.399.64.37.0 | 05.399.64.16.0 | 05.399.64.39.0 |
| 443            | Støddæmper                   | 02.3722.29.01  | 02.3722.25.01  | 02.3722.43.00  |
| 447            | Anslagsklods                 | 03.060.03.25.0 | 03.060.03.25.0 | 03.060.03.25.0 |
| 449            | Gummibælg                    | 03.130.08.15.0 | 03.130.08.15.0 | 03.130.08.15.0 |
| 451            | Glidebøsning Forreste        | 03.030.12.97.0 | 03.030.12.97.0 | 03.030.13.11.0 |
| 452            | Glidebøsning Bageste         | 03.030.12.96.0 | 03.030.12.96.0 | 03.030.13.10.0 |
| 455            | Smørenippel                  | 02.6850.22.00  | 02.6850.22.00  | 02.6850.20.00  |
| 461            | Afstandsbøsning              | 03.302.21.75.0 | 03.302.21.75.0 | 03.302.21.75.0 |
| 465            | Afslutningsdæksel            | 03.211.02.04.0 | 03.211.02.04.0 | 03.211.02.04.0 |
| 481            | Gevindbolt f/håndbremsegreb  | 03.177.11.31.0 | 03.177.11.31.0 | 03.177.11.31.0 |
| 490            | Håndbremsegreb               | 05.203.30.15.0 | 05.203.30.15.0 | 05.203.30.15.0 |
| 497            | Sikkerhedswire               | 102.46022      | 102.46022      | 102.46022      |
| 503            | Skive, kunststof f/ZAF 3,5-1 | 02.5450.63.0   | 02.5450.63.0   | 02.5450.63.0   |
| 510            | Fjederholder                 | 05.397.68.48.0 | 05.397.68.49.0 | 05.397.68.53.0 |
| 521            | Udvekslingsled / KH          | 05.190.39.24.0 | 05.190.39.24.0 | 05.190.39.24.0 |
| 524            | Gaffelstykke                 | 03.171.02.41.0 | 03.171.02.41.0 | 03.171.02.41.0 |
| 526            | Bolt til gaffelstykke        | 02.5850.26.02  | 02.5850.26.02  | 02.5850.26.02  |
| 527            | Sikringslås for bolt         | 02.3301.04.02  | 02.3301.04.02  | 02.3301.04.02  |

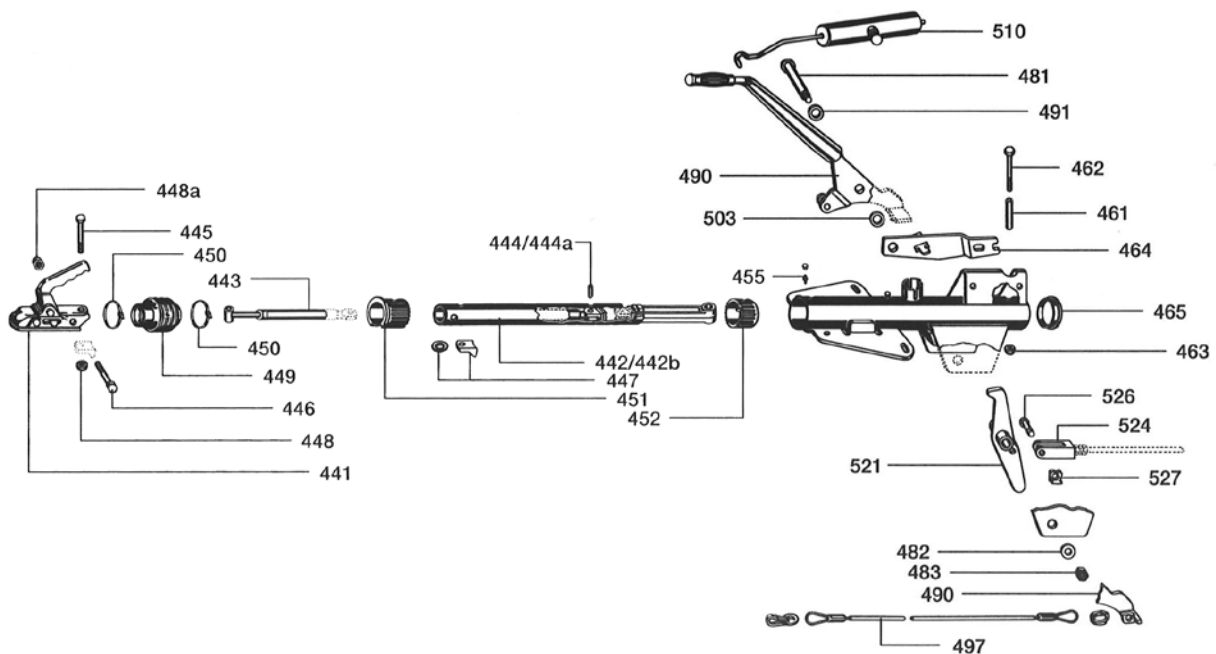

## BPW / ZAF -2

| Nr. på påløbet |                                 | 48.20.58x.xxx   | 48.27.58x.xxx   | 48.36.58x.xxx   | 48.44.58x.xxx   |
|----------------|---------------------------------|-----------------|-----------------|-----------------|-----------------|
|                |                                 | ZAF 1,0-2       | ZAF 1,5-2       | ZAF 2,0-2       | ZAF 2,8-2       |
| 441            | Kuglekobling                    | 5345            | 5345            | 5545            | 5650            |
| 442            | Trykstang                       | 05.399.69.69.0  | 05.399.69.85.0  | 05.399.69.87.0  | 05.399.69.90.0  |
| 443            | Støddæmper                      | 02.3722.59.00   | 02.3722.75.00   | 02.3722.77.00   | 02.3722.80.00   |
| 449            | Gummibælg                       | 03.130.09.16.0  | 03.130.09.16.0  | 03.130.09.16.0  | 03.130.09.16.0  |
| 451            | Glidebøsning                    | 03.030.30.07.0  | 03.030.30.10.0  | 03.030.30.10.0  | 03.030.30.12.0  |
| 452            | Glidebøsning (ikke afbilledet)  | 03.030.30.08.0  |                 |                 |                 |
| 455            | Smørenippel                     | 02.6850.22.00   | 02.6850.23.00   | 02.6850.23.00   | 02.6850.23.00   |
| 462            | Gevindbolt m/anslagsklods       | 05.178.00.08.0  | 05.178.00.05.0  | 05.178.00.05.0  | 05.178.00.05.0  |
| 465            | Dæmperring                      | 05.5683.55.0    | 03.311.20.18.0  | 03.311.20.18.0  | 03.311.20.18.0  |
| 490            | Håndbremsegreb alm.             | 05.203.30.28.0  | 05.203.30.28.0  | 05.203.30.28.0  | 05.203.30.32.0  |
|                | Håndbremsegreb undermont.       | 05.203.30.25.0  | 05.203.30.25.0  | 05.203.30.25.0  |                 |
| 491            | Monterings sæt f/sikkerhedswire | 05.803.02.76.0  | 05.803.02.76.0  | 05.803.02.76.0  | 05.803.02.76.0  |
| 497            | Sikkerhedswire                  | 05.327.30.02.0  | 05.327.30.02.0  | 05.327.30.02.0  | 05.327.30.02.0  |
| 510            | Trækfjeder                      | 05.397.68.61.0  | 05.397.68.61.0  | 05.397.68.60.0  | 05.397.68.62.0  |
| 521            | Udvekslingsled                  | 05.803.12.34.0  | 05.190.38.75.0  | 05.190.38.75.0  | 05.190.38.85.0  |
| 522            | Smørenippel - kegleformet       | 02.6850.01.02.0 | 02.6850.01.02.0 | 02.6850.01.02.0 | 02.6850.01.02.0 |
| 523            | Sikringssskive 14mm             | 02.5450.88.00   | 02.5450.88.00   | 02.5450.88.00   | 02.5450.88.00   |
| 524            | Gaffelstykke                    | 02.1201.02.12   | 02.1201.02.12   | 02.1201.02.12   | 02.1201.02.12   |
| 526            | Bolt til gaffelstykke           | 02.5850.26.02   | 02.5850.26.02   | 02.5850.26.02   | 02.5850.26.02   |
| 527            | Sikringslås for bolt            | 02.3301.04.02   | 02.3301.04.02   | 02.3301.04.02   | 02.3301.04.02   |

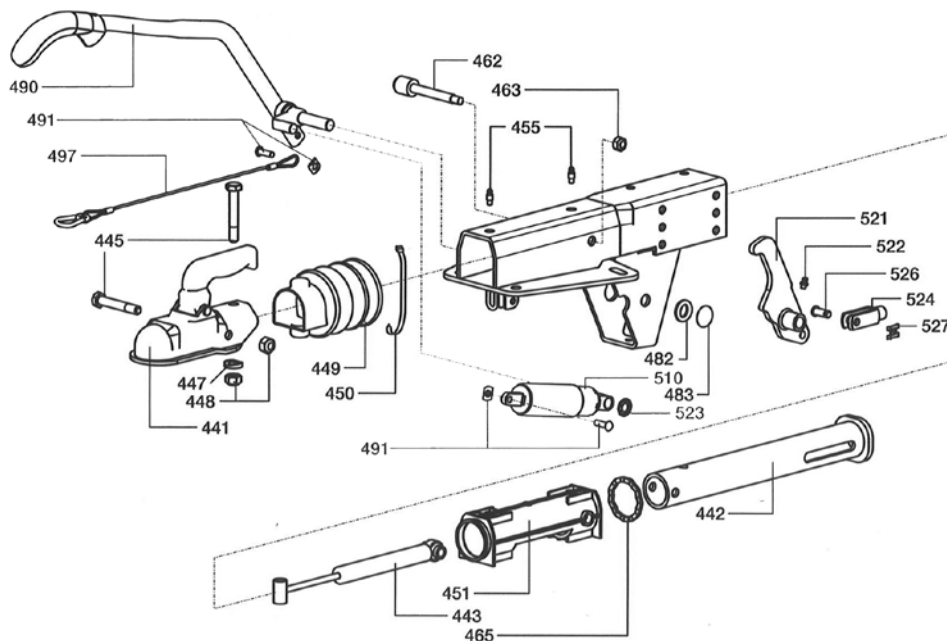

**PEITZ - udførsel M**

| Nr. på påløbet | PAV/SR 0,7             | PAV/SR 1,3     | PAV/SR 2,0     | PAV/SR 2,7     |                |
|----------------|------------------------|----------------|----------------|----------------|----------------|
| 441            | Kuglekobling           | 5345           | 5345           | 5545           | 5650           |
| 442b           | Trykstang              | 05 399 60 10 0 | 05 399 60 10 0 | 05 399 60 09 0 | 05 399 60 12 0 |
| 443            | Støddæmper             | 10 30 972041   | 02.3722.47.00  | 02.3722.46.00  | 02.3702.48.00  |
| 447            | Anslagsklods           | 03.060.03.25.0 | 03.060.03.25.0 | 03.060.03.25.0 | 03.060.03.25.0 |
| 449            | Gummibælg              | 10.30.972042   | 03.130.08.20.0 | 03.130.08.20.0 | 03.130.09.12.0 |
| 451            | Glidebøsning Forreste  | 03.113.95.03.0 | 03.030.12.97.0 | 03.030.12.97.0 | 03.030.13.10.0 |
| 452            | Glidebøsning Bageste   | 03.113.95.03.0 | 03.030.12.96.0 | 03.030.12.96.0 | 03.030.13.11.0 |
| 454            | Afslutningsdæksel      | 03.211.01.12.0 | 03.211.02.04.0 | 03.211.02.04.0 | 03.211.02.04.0 |
| 455            | Smørenippel            | 02.6850.20.00  | 02.6850.22.00  | 02.6850.22.00  | 02.6850.22.00  |
| 455a           | Prop til smørenippel   | 02.3704.19.00  | 02.3704.19.00  | 02.3704.19.00  | 02.3704.19.00  |
| 461            | Afstandsbøsning        | 03.301.00.12.0 | 03.302.21.75.0 | 03.302.21.75.0 | 03.302.21.75.0 |
| 490            | Håndbremsegreb         |                |                |                |                |
|                | X=15/370lgd            | 05.203.03.41.0 | 05.203.03.41.0 | 05.203.03.41.0 | 05.203.03.41.0 |
|                | X=15/450lgd            |                | 05.203.03.43.0 | 05.203.03.43.0 | 05.203.03.43.0 |
|                | X=33/370lgd            | 10.30.972297   | 10.30.972297   | 10.30.972297   | 10.30.972297   |
|                | X=37/450lgd            |                | 05.203.03.42.0 | 05.203.03.42.0 | 05.203.03.42.0 |
|                | X=47/450lgd            |                | 10.30.972112   | 10.30.972112   | 10.30.972112   |
| 497            | Sikkerhedswire         | 102.46022      | 102.46022      | 102.46022      | 102.46022      |
| 521            | Udvekslingsled         | 10.30.570021   | 10.30.570021   | 10.30.570021   | 10.30.570021   |
| 522a           | Bremsestang m/strammer | 05 803 18 04 0 | 05 803 18 04 0 | 05 803 18 04 0 | 05 803 18 04 0 |

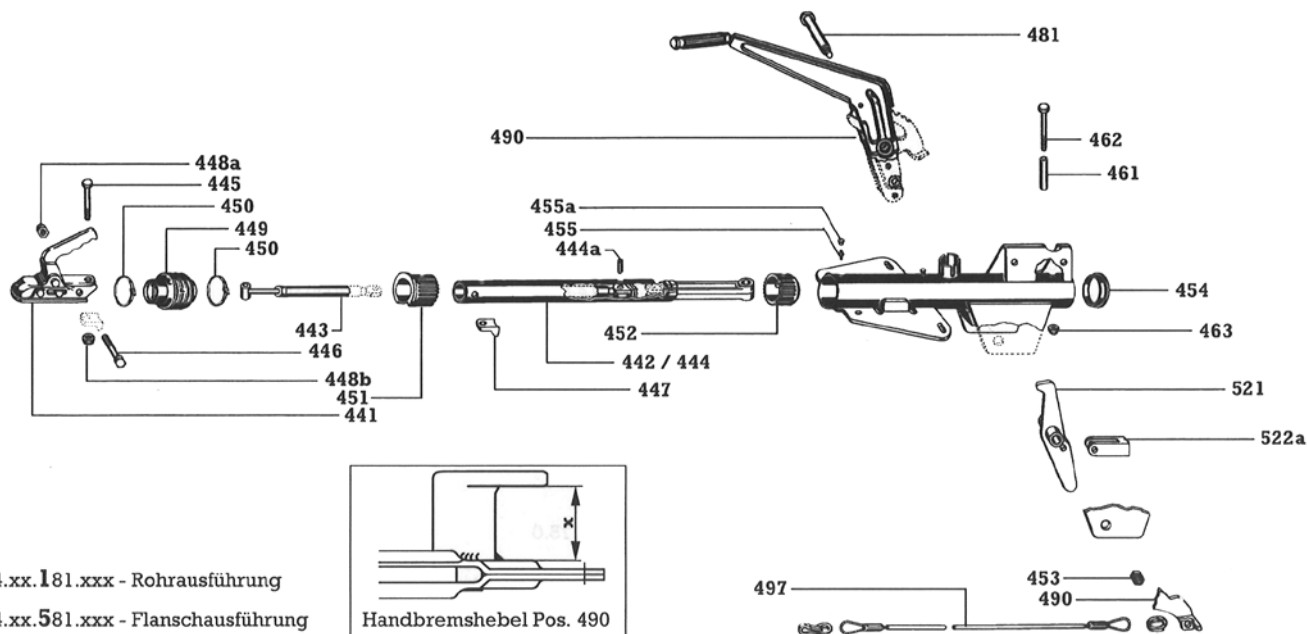

## PEITZ/BPW - udførsel MX

| Nr. på påløbet |                                   | PAV/SR 0,7     | PAV/SR 1,3     | PAV/SR 2,0     | PAV/SR 2,7     |
|----------------|-----------------------------------|----------------|----------------|----------------|----------------|
| 441            | Kuglekobling                      | 5345           | 5345           | 5545           | 5650           |
| 442b           | Trykstang                         | 05.399.64.37.0 | 05.399.64.37.0 | 05.399.64.16.0 | 05.399.64.39.0 |
| 443            | Støddæmper                        | 02.3722.44.00  | 02.3722.27.01  | 02.3722.25.01  | 02.3722.43.00  |
| 447            | Anslagsklods                      | 03.060.03.25.0 | 03.060.03.25.0 | 03.060.03.25.0 | 03.060.03.25.0 |
| 449            | Gummibælg                         | 03.130.08.16.0 | 03.130.08.15.0 | 03.130.08.15.0 | 03.130.08.15.0 |
| 451            | Glidebøsning Forreste             | 03.113.95.03.0 | 03.030.12.97.0 | 03.030.12.97.0 | 03.030.13.10.0 |
| 452            | Glidebøsning Bageste              | 03.113.95.03.0 | 03.030.12.96.0 | 03.030.12.96.0 | 03.030.13.11.0 |
| 454            | Afslutningsdæksel                 | 03.211.01.12.0 | 03.211.02.04.0 | 03.211.02.04.0 | 03.211.02.04.0 |
| 455            | Smørenippel                       | 02.6850.20.00  | 02.6850.22.00  | 02.6850.22.00  | 02.6850.22.00  |
| 455a           | Prop til smørenippel              | 02.3704.19.00  | 02.3704.19.00  | 02.3704.19.00  | 02.3704.19.00  |
| 461            | Afstandsبøsning                   | 03.301.00.12.0 | 03.302.21.75.0 | 03.302.21.75.0 | 03.302.21.75.0 |
| 490            | Håndbremssegreb                   |                |                |                |                |
|                | KH                                | 05.203.03.17.0 | 05.203.03.17.0 | 05.203.03.17.0 | 05.203.03.17.0 |
|                | HF/6° vinkel<br>(med tandsegment) | 05.203.03.23.0 | 05.203.03.23.0 | 05.203.03.23.0 | 05.203.03.23.0 |
| 497            | Sikkerhedswire                    | 102.46022      | 102.46022      | 102.46022      | 102.46022      |
| 510            | Fjederbøsning KH                  | 05.397.68.48.0 | 05.397.68.48.0 | 05.397.68.49.0 |                |
|                | Fjederbøsning HF / R48            | 02.1010.26.00  | 02.1010.26.00  |                |                |
|                | Fjederbøsning HF / RD52           |                |                | 05.397.68.52.0 |                |
|                | Fjederbøsning HF / 2,7x           |                |                |                | 10.30.972895   |
|                | Fjederbøsning KH /3500kg          |                |                |                | 05.397.68.53.0 |
| 521            | Udvekslingsled / KH               | 03.171.02.41.0 | 03.171.02.41.0 | 03.171.02.41.0 | 03.171.02.41.0 |
|                | Udvekslingsled / HF               | 10.30.572294   | 10.30.572294   | 10.30.572294   | 10.30.572294   |
| 550            | Holder for fjederbøsning/KH       | 05.189.41.50.0 | 05.189.41.50.0 | 05.189.41.50.0 | 05.189.41.50.0 |
|                | Holder for fjederbøsning/HF       | 02.1023.09.00  | 02.1023.09.00  | 02.1023.09.00  | 02.1023.09.00  |

48.xx.181.xxx - Rohrausführung

48.xx.581.xxx - Flanschausführung

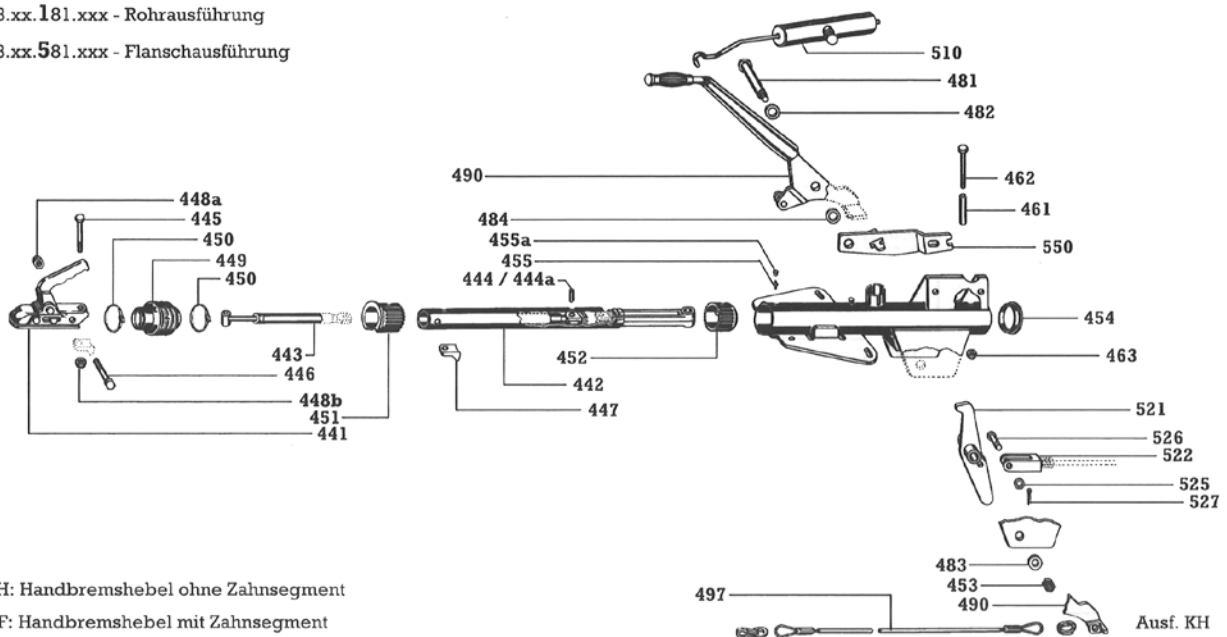

KH: Handbremshebel ohne Zahnsegment

HF: Handbremshebel mit Zahnsegment

Ausf. KH



**Knott KF**

| Nr. på påløbet |                             | KF7,5/GTA 0,75 | KF 13/GTA1,3   | KF 17/GTA1,7   | KF 20/GTA2,1A          | KF 27/KFG30A   |
|----------------|-----------------------------|----------------|----------------|----------------|------------------------|----------------|
| 441            | Kuglekobling                | 5345           | 5345           | 5545           | 5545                   | 5545           |
| 442            | Trykstang GTA               | 05.399.26.46.0 | 05.399.26.46.0 | 05.399.21.90.0 | 802003                 |                |
| 442            | Trykstang Knott             |                | 218.98103094   | 218.98103094   | 218.98103094           | 218.98103894   |
| 443            | Støddæmper GTA              | 02.3722.06.00  | 02.3722.07.00  | 02.3722.08.00  | 02.3722.08.00          |                |
| 443            | Støddæmper Knott            | 218.87000313   | 218.87000713   | 218.870001113  | 218.870001113          | (87003913)     |
| 449            | Gummibælg GTA               | 03.130.08.02.0 | 03.130.08.02.0 | 03.130.08.02.0 | 03.130.08.02.0         |                |
| 449            | Gummibælg Knott             | 218.69004692   | 218.69004692   | 218.69004692   | 218.69004692           | 218.69004692   |
| 451            | Glidebøsning                | 03.030.12.71.0 | 218.69005094   | 218.69005094   | 218.69005094           | 218.69005194   |
| -              | Glidebøsning m/slids og tap |                | 218.604030     | 218.604030     | 218.604030             | 218.200364.002 |
| 464            | Støddæmpeholder             | 03.189.41.52.0 | 03.189.41.52.0 | 03.189.41.52.0 | 03.189.41.51.0         | 03.189.41.51.0 |
| -              | Bolt for håndbremsegreb KH  | 03.177.11.31.0 | 03.177.11.31.0 | 03.177.11.31.0 | 03.177.11.31.0         | 03.177.11.31.0 |
| -              | Bolt for håndbremsegreb HF  | 03.177.11.25.0 | 03.177.11.25.0 | 03.177.11.25.0 | (udf.C) 03.177.11.25.0 |                |
| 490            | Håndbremsegreb KH           | 05.203.03.17.0 | 05.203.03.17.0 | 05.203.03.17.0 | 05.203.03.17.0         | 05.203.03.17.0 |
| -              | Håndbremsegreb HF           | 05.203.03.23.0 | 05.203.03.23.0 | 05.203.03.23.0 | 05.203.03.23.0         | 05.203.03.23.0 |
| -              | Håndbremsegreb GF           | 218.201943.001 | 218.201943.001 | 218.201943.001 | 218.201943.001         | 218.201943.001 |
| 497            | Sikkerhedswire              | 102.46022      | 102.46022      | 102.46022      | 102.46022              | 102.46022      |
| 510            | Fjederholder KH (Ø48)       | 05.397.68.48.0 | 05.397.68.48.0 | 05.397.68.48.0 | (udf.A) 05.397.68.49.0 |                |
| -              | Fjederholder KH (Ø53)       | 02.1010.26.00  | 02.1010.26.00  | 02.1010.26.00  |                        |                |
| -              | Fjederholder HF (Ø48)       |                |                |                | (udf.C) 05.397.68.53.0 |                |
| -              | Fjederholder HF (Ø52)       |                |                | 05.397.68.52.0 | (udf.C) 05.397.68.52.0 |                |
| -              | Fjederholder GF             | 218.201856.001 | 218.201856.001 | 218.201856.001 | 218.201856.001         | 218.201856.001 |
| 521            | Udvekslingsled KH           | 05.190.36.94.0 | 05.190.36.94.0 | 05.190.36.94.0 | (udf.A) 05.190.36.99.0 |                |
| -              | Udvekslingsled HF           |                |                |                | (udf.C) 10.30.571856   |                |
| -              | Udvekslingsled GF           | 98722483       | 98722483       | 98722483       | 98722483               | 200406.001     |
| -              | Gaffelstykke M10            | 03.171.02.41.0 | 03.171.02.41.0 | 03.171.02.41.0 | 03.171.02.41.0         |                |

**KF 7,5 - KF 30**

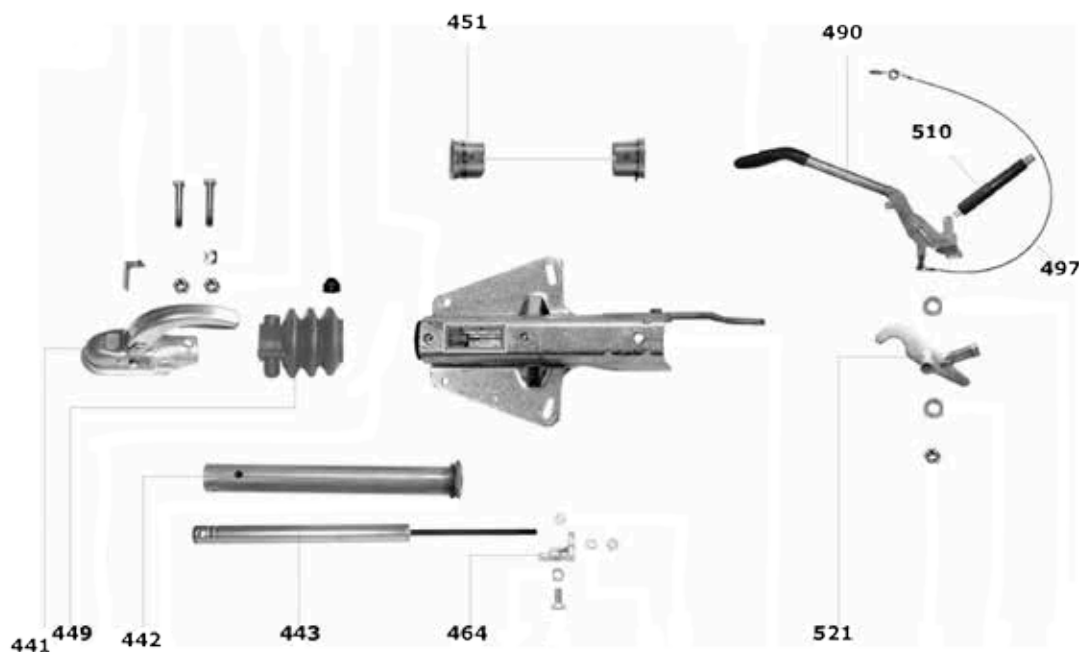

## Campingvogns presenninger

| Længde/bund | Længde/top | Bredde | Højde  | Varenummer   |
|-------------|------------|--------|--------|--------------|
| 425 cm      | 370 cm     | 240 cm | 228 cm | 44.65951     |
| 520 cm      | 450 cm     | 240 cm | 228 cm | 44.65952     |
| 580 cm      | 500 cm     | 240 cm | 228 cm | 44.65953     |
| 640 cm      | 555 cm     | 240 cm | 228 cm | 44.65954     |
| 700 cm      | 610 cm     | 240 cm | 228 cm | 44.65955     |
| 640 cm      | 555 cm     | 258 cm | 228 cm | 44.65954-250 |
| 700 cm      | 610 cm     | 258 cm | 228 cm | 44.65955-250 |
| 760 cm      | 660 cm     | 258 cm | 228 cm | 44.65956-250 |
| 830 cm      | 730 cm     | 258 cm | 228 cm | 44.65957-250 |

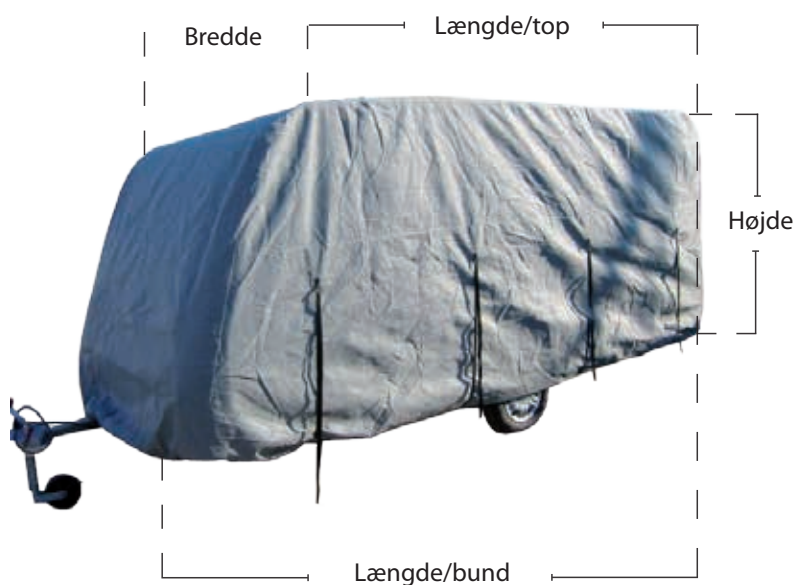

Længde bund er lig største udvendige længde på kassen incl. gaskassen.

### OBS!





Ovenstående er presenningens mål!



Vi anbefaler at campingvognen er min. 10 cm mindre end de angivne mål.

Alle modeller leveres i et kraftigt, robust, åndbart og vandafvisende materiale. Inkl. opbevaringspose.

Farve: grå

## Toilettilbehør

|   | Betegnelse  | Varenummer |
|---|---|------------|
|    | <b>Aqua rinse plus, 1.5 ltr</b><br>Multifunktionelt rensmiddel til skyllevand, der forbedrer toilethygiejnen.<br>Indhold/karton: 6 fl á 1.5 ltr<br>Doseringen: 100 ml. pr. 15 ltr.                        | 30358-AE   |
|   | <b>Aqua kem green, 1.5 ltr</b><br>Indhold/karton: 6 fl á 1.5 ltr.<br>En toiletvæske til daglig brug med biologiske aktivitet.<br>Dosering: 75ml. pr. 10 ltr.  | 30246-AP   |
|  | <b>Aqua kem sachets, 1 dåse</b><br>Til toilettets affaldstank<br>6 dåser pr. karton<br>Paller af 140 kartoner<br>1 dåse 15 breve<br>1 brev anvendes til 20 liter  | 30262-AE   |
|  | <b>Toiletpapir, aqua soft 4-pak</b><br>Dette er et specielt designet, blødt toiletpapir, der opløser hurtigt i affaldstanken. Dette vil forhindre tilstopning og kan forenkle tømningen af affaldstanken. | 21946      |

| Toiletter Porta Potti  |   |            |
|--|---|------------|
|  | Betegnelse  | Varenummer |
|   | <p><b>Toilet Porta Potti Qube 365 White</b><br/>                     Farve: Hvid<br/>                     Udv. mål: 414 x 383 x 427 mm<br/>                     Vægt: 4 kg<br/>                     Skylltank: 15 Ltr.<br/>                     Tømningstank: 21 Ltr.<br/>                     Indikator på tømningstank<br/>                     Fabrikat: Thetford</p>  | 92817      |
|  | <p><b>Toilet Porta Potti Excellence Electric</b><br/>                     Farve: Granit<br/>                     Udv. mål: 448 x 388 x 450 mm<br/>                     Vægt: 5,5 kg<br/>                     Skylltank: 15 Ltr.<br/>                     Tømningstank: 21 Ltr.<br/>                     Integreret toiletrulle-holder<br/>                     Bærehåndtag for skylletank<br/>                     Elektrisk pumpe<br/>                     Indikator på skylletank og tømningstank<br/>                     Fabrikat: Thetford</p> | 92320      |

| Skraberist m/koste  |   |            |
|---|---|------------|
|   | Betegnelse                                    | Varenummer |
|  | <p><b>Galvaniseret rist med koste</b></p>     | 48.sr-03   |
|  | <p><b>Støtte for skraberist med koste</b></p> | 48.sr-03st |

## Plastikfod til skamler / trapper

|   | Betegnelse  | Varenummer |
|---|---|------------|
|  | <p><b>Plastikfod til skamler/stationær trappe</b><br/>Sæt med 5 stk. Passer til 48.sdw301</p> <p>Sikrer at din skammel/trappe ikke synker ned i jorden eller laver mærker i fortelttæppet. Også velegnet til teltstænger.</p> | 48.pfs-02  |
|  | <p><b>Plastikfod til skamler/trapper</b><br/>Sæt med 4 stk. Passer til 48.sdw300</p> <p>Sikrer at din skammel/trappe ikke synker ned i jorden eller laver mærker i fortelttæppet. Også velegnet til teltstænger.</p>          | 48.pfs-01  |





### Hestetrailer-Presenninger

| Længde  | Bredde  | Højde   | Varenummer |
|---------|---------|---------|------------|
| 3300 mm | 2150 mm | 2350 mm | 44.CV-01   |
| 3600 mm | 2150 mm | 2400 mm | 44.CV-02   |
| 3700 mm | 2300 mm | 2400 mm | 44.CV-03   |
| 3700 mm | 2300 mm | 2400 mm | 44.CV-03a  |



Alle modeller leveres i et kraftigt, robust, åndbart og vandafvisende materiale. Inkl. opbevaringspose.  
Farve: grå



Tilbehør - Hestetrailer

|   | Betegnelse   | Varenummer |
|---|--|------------|
|    | <b>Fjongstrop med S-krog</b>   | 55180      |
|    | <b>Fjongstrop til bagklap presenning</b><br>T-strop med 3 huller, 285 mm                       | 553280     |
|  | <b>Sidepolstring til hestetrailer</b><br>750 x 250 x 15 mm<br>med lim på bagside, grå          | 110.sp-1   |
|  | <b>Påløbsovertræk</b><br>Til hestetrailer med fastmonteret støttehjul (med kip),<br>sort nappa | 110.po-1   |

| Bådtilbehør   |   |             |
|---|---|-------------|
|   | Betegnelse  | Varenummer  |
|    | <b>Stævnstøtte</b><br>Bådtrailer, hul Ø22 mm, 0,6 kg                      | 26475       |
|    | <b>Stævnstøtte</b><br>150x70x80 mm  | 2432.D41200 |
|  | <b>Siderulle 85 mm</b><br>Hul Ø22 mm, 1,4 kg,<br>Største diameter: 145 mm | 26438       |
|  | <b>Siderulle 74 mm</b><br>Hul Ø21 mm<br>Største diameter: 120 mm          | 2432.D40102 |



Bådtilbehør



|   | Betegnelse  | Varenummer  |
|---|---|-------------|
|  | <b>Kølrulle 190 mm</b><br>Hul Ø22 mm<br>Største diameter: 95 mm<br>Belastning: 500 kg | 2432.D40118 |
|  | <b>Kølrulle 206 mm</b><br>Hul Ø21 mm<br>Største diameter: 98 mm<br>Belastning: 500 kg | 2432.D40124 |

Fortøjningsfjeder

|   | Betegnelse   | Varenummer |
|---|--|------------|
|  | <b>Fortøjningsfjeder 6-12 mm</b><br>Reb for både op til 500 kg<br>Længde: 440 mm   | 177.mc1501 |
|  | <b>Fortøjningsfjeder 14-18 mm</b><br>Reb for både op til 3000 kg<br>Længde: 500 mm | 177.mc1502 |

| Fortøjningsreb  |  |            |
|---|--|------------|
|   | Betegnelse   | Varenummer |
|  | Fortøjningsreb, 40 m x 12mm, hvid<br>Brudstyrke 2170 kg  | 176.mr12-1 |
|   | Fortøjningsreb, 40 m x 12 mm, blå<br>Brudstyrke 2170 kg  | 176.mr12-2 |
|   | Fortøjningsreb, 40 m x 14 mm, hvid<br>Brudstyrke 2990 kg | 176.mr14-1 |
|   | Fortøjningsreb, 40 m x 14 mm, blå<br>Brudstyrke 2990 kg  | 176.mr14-2 |
|   | Fortøjningsreb, 40 m x 16 mm, hvid<br>Brudstyrke 3700 kg | 176.mr16-1 |
|   | Fortøjningsreb, 40 m x 16 mm, blå<br>Brudstyrke 3700 kg  | 176.mr16-2 |
|   | Fortøjningsreb, 40 m x 18 mm, hvid<br>Brudstyrke 4720 kg | 176.mr18-1 |
|   | Fortøjningsreb, 40 m x 18 mm, blå<br>Brudstyrke 4720 kg  | 176.mr18-2 |

Alle reb leveres i soft, 3-slået, polypropylen, >15% forlængelse. Blødt og smidigt tovværk. UV stabiliseret. Flyder på vand. Varmebehandlet.

| Håndspil  |  |            |
|---|--|------------|
|   | Betegnelse   | Varenummer |
|  | <b>Håndspil, 800 kg med 8 mtr. trækbånd</b><br>Galvaniserede 2-vejs spil, med krog<br>Bremser ved både ophaling og aflæsning | 800L7      |
|  | <b>Håndspil, 800 kg med 10 mtr. wire</b><br>Galvaniserede 2-vejs spil, med krog<br>Bremser ved både ophaling og aflæsning    | 800w10     |

## Bådpreseining til optimistjolle

|   | Betegnelse                                    | Varenummer |
|---|---|------------|
|  | <b>Bådpreseining</b><br>Optimistjolle, 3 lags | 110.bc-01  |

## Jollevojn

|  | Betegnelse   | Varenummer |
|--|--|------------|
|  | <b>Jollevojn, for optimistjolle, sammenklappelig</b><br>Vægt: 13 kg<br>aluminium | 48.tr-01   |

## Båd presenninger til motorbåd

|  | Betegnelse                       | Varenummer |
|--|----------------------------------|------------|
|  <p><i>m/påhængsmotor</i></p> | Max længde 567 cm, bredde 254 cm | 44.666112  |
|  | Max længde 597 cm, bredde 259 cm | 44.666114  |

## Båd presenninger til "EURO"

|   | Betegnelse                       | Varenummer |
|---|----------------------------------|------------|
|  <p><i>m/påhængsmotor</i></p> | Max længde 597 cm, bredde 259 cm | 44.666132  |
|   | Max længde 628 cm, bredde 264 cm | 44.666133  |

## Båd presenninger til "EURO"

|   | Betegnelse                       | Varenummer |
|---|----------------------------------|------------|
|  <p><i>m/indenbordsmotor</i></p> | Max længde 567 cm, bredde 254 cm | 44.666135  |

Alle båd presenninger leveres i vandafvisende og åndbart materiale, med indsyet elastik, inkl. fastgørelsesbånd og opbevaringspose, farve: grå

**Båd presenninger  
til "EURO V-HULL CUDDY CABIN"**

|   | Betegnelse                       | Varenummer |
|---|----------------------------------|------------|
|  <p><i>m/indenbordsmotor</i></p> | Max længde 628 cm, bredde 264 cm | 44.666143  |
|   | Max længde 658 cm, bredde 264 cm | 44.666144  |

**Båd presenninger  
til "WALK AROUND CUDDY CABIN"**

|  | Betegnelse                       | Varenummer |
|--|----------------------------------|------------|
|  <p><i>m/indenbordsmotor</i></p> | Max længde 628 cm, bredde 249 cm | 44.666165  |

**Båd presenninger til "VANDSKIBÅD"**

|   | Betegnelse                       | Varenummer |
|---|----------------------------------|------------|
|  <p><i>m/indenbordsmotor</i></p> | Max længde 536 cm, bredde 216 cm | 44.666188  |

## Båd presenninger til "VANDSKIBÅD"

|   | Betegnelse                       | Varenummer |
|---|----------------------------------|------------|
|  <p>m/påhængsmotor</p> | Max længde 506 cm, bredde 208 cm | 44.666192  |
|   | Max længde 536 cm, bredde 216 cm | 44.666193  |
|   | Max længde 567 cm, bredde 226 cm | 44.666194  |
|   | Max længde 597 cm, bredde 226 cm | 44.666195  |

## Monteringsstang til bådpresenninger

|   | Betegnelse  | Varenummer |
|---|---|------------|
|  | Monteringsstang til bådpresenninger, teleskopisk, aluminium, længde 66-163 cm | 44.66211   |

## Påhængsmotor presenninger

|   | Betegnelse   | Varenummer |
|---|--|------------|
|  | Påhængsmotor presenninger, op til 25 hk, længde 48 cm, bredde 41 cm, højde 35 cm                       | 44.66022   |
|   | Påhængsmotor presenninger, op til 60 hk, længde 76 cm, bredde 38 cm, højde 41 cm                       | 44.66023   |
|   | Påhængsmotor presenninger for Johnson/Evinrude, op til 115 hk, længde 76 cm, bredde 41 cm, højde 53 cm | 44.66024   |
|   | Påhængsmotor presenninger, op til 115 hk, længde 76 cm, bredde 43 cm, højde 89 cm                      | 44.66025   |

Påhængsmotor presenninger i vandafvisende og åndbart materiale, beskytter påhængsmotoren mod al slags vejr, farve: grå

### Transportvogn for bådmotor

|   | Betegnelse   | Varenummer |
|---|--|------------|
|  | <p>Transportvognen er justerbar i højden, og dermed egnet til både kortbenede og langbenede motorer.</p> <p>Belastningsevnen er 70 kg. hvilket gør den egnet til de fleste motorer op til ca. 30 hk.</p> | 48.svb-1   |

### Gangbro til bådtrailere

|  | Betegnelse   | Varenummer     |
|--|--|----------------|
|  | Rampe for gangbro, 40 cm aluminium, belastning 200 kg  | 55.400L-200-S  |
|  | Rampe for gangbro, 60 cm aluminium, belastning 200 kg  | 55.600L-200-S  |
|  | Rampe for gangbro, 80 cm aluminium, belastning 200 kg  | 55.800L-200-S  |
|  | Rampe for gangbro, 100 cm aluminium, belastning 200 kg | 55.1000L-200-S |
|  | Rampe for gangbro, 120 cm aluminium, belastning 200 kg | 55.1200L-200-S |

### Beslag for gangbro



|   | Betegnelse   | Varenummer |
|---|--|------------|
|  | <p>Komplet med U-bøjle, til 40 mm vange<br/>Der skal benyttes 2 stk. pr. rampe</p> | 42.SRSU-01 |

| Motorcykel presenninger   |   |            |
|---|---|------------|
|   | Betegnelse  | Varenummer |
|  | <p><b>Motorcykel presenninger</b><br/>                     Farve: sort-/sølvfarvet<br/>                     Størrelse: large - passer op til 1100 ccm</p> <p>Passer til motorcykler - både med og uden tilbehør, udført i varmemodståeligt materiale leveres i et stærkt, holdbart og vandafvisende materiale og har elastik i bunden, hvilket giver en perfekt pasform. Inkl. opbevaringspose.</p> | 44.63113   |

| Scooter presenninger   |  |            |
|--|--|------------|
|  | Betegnelse   | Varenummer |
|  | <p><b>Scooter presenninger</b><br/>                     farve: sølv<br/>                     Størrelse: Medium<br/>                     Længde: 122 cm<br/>                     Bredde: 56 cm<br/>                     Højde: 112 cm</p> | 44.64132   |



## Overtræksposer

|   | Betegnelse  | Varenummer |
|---|---|------------|
|  | Overtrækspose for 6 kg ildslukker, farve: rød           | 110.isc-01 |
|  | Overtrækspose for 6 kg ildslukker i pvc-dug, farve: rød | 110.isc-02 |

### Kontaktoplysninger

Er der spørgsmål til vores produkter her i kataloget eller er der brug for yderligere informationer også omkring andre produkter - så er du velkommen til at kontakte os.

Hele vores produktprogram kan findes på vores webshop og onlinekatalog [www.ttonline.dk](http://www.ttonline.dk)

**Lars Stender**

Salgschef / Sales Manager

Tlf. +45 76 34 82 25

Mobil +45 40 53 50 19

E-mail: [lst@bpw.dk](mailto:lst@bpw.dk)

**Pernille Pedersen**

Internt salg / Internal sales

Tlf. +45 76 34 82 18

E-mail: [ppe@bpw.dk](mailto:ppe@bpw.dk)

**Sigrid L. Andersen**

Internt salg / Internal sales

Tlf. +45 76 34 82 19

E-mail: [sla@bpw.dk](mailto:sla@bpw.dk)

Fælles mailboks: [forzaline@bpw.dk](mailto:forzaline@bpw.dk)



Member of the BPW Group



Oktober 2015 \_version 2.5



Vranderupvej 2 • DK-6000 Kolding  
Bjerringbrovej 116 • DK-2610 Rødovre  
Tlf. +45 75 52 52 00 • Tlf. +45 39 69 68 00  
[www.transport-teknik.dk](http://www.transport-teknik.dk) • [www.ermak.dk](http://www.ermak.dk)